

EXPORT CATALOGUE

EFFECTIVE FROM JANUARY 2024

TYRE CHANGERS





AND ORIGINAL ACCESSORIES



SICE
AUTOMOTIVE EQUIPMENT

REL. MAY 2024

TABELLA COLORI

Standard		RAL 1007	Yellow	A => /40
Optional		RAL 3002	Red	B => /16
Optional		RAL 5015	Blue	C => /25
Optional		RAL 9006	Light Grey	D => /36

Main frame is always dark grey RAL 7016 

NEXION SPA reserves the right to change the specifications of its products at any time without prior notice. The company declines all responsibility in the event of claims deriving from the use of non-original accessories or spare parts with consequent forfeiture of the EC declaration of conformity.

SUMMARY

TRADITIONAL SEMI-AUTOMATIC MOTORCYCLE TYRE CHANGER	4	AUTOMATIC TRUCK TYRE CHANGER	63
M39 ATV	4	S 55 - S 55A	63
ACCESSORIES MOTORCYCLE TYRE CHANGERS M39 ATV	5	S 560	64
S 41 E CROSS	7	S 60	65
ACCESSORIES MOTORCYCLE TYRE CHANGERS S 41 E CROSS	8		
TRADITIONAL SEMI-AUTOMATIC CAR TYRE CHANGER	9	"LEVER-LESS" TRUCK TYRE CHANGER	66
S 41 E	9	S 58LL	66
S 41 E MAXI	10		
TRADITIONAL AUTOMATIC CAR TYRE CHANGER	11	TRUCK TYRE CHANGERS FOR MOBILE SERVICE	67
S 42 E	11	S 50A MOBILE	67
S 43 - S 43 A	12	S 50 MOBILE	68
S 45 BASIC	13	ACCESSORIES FOR TRUCK TYRE CHANGER	69
S 45	14		
S 45 TOP	15		
CAR TYRE CHANGER FOR MOBILE SERVICE	16		
S 44 M	16		
ACCESSORIES FOR "TRADITIONAL" CAR TYRE CHANGERS	17		
"LEVERLESS" CAR TYRE CHANGER	33		
S 45 TL	33		
S 45 TL TOP	34		
S 48 TL TOP	35		
S 200	36		
S 200 A	37		
SERIE S 300	38		
S 1000 EVOLUZIONE S.L.	39		
S 1000 EVOLUZIONE P.L.	40		
S 1000 EVOLUZIONE A P.L.	41		
ACCESSORIES FOR "LEVERLESS" CAR TYRE CHANGERS	42		
SEMI-AUTOMATIC TRUCK TYRE CHANGER	58		
S 52 A	58		
S 53	59		
S 54	60		
S 54 A	61		
S 560 M	62		

TRADITIONAL SEMI-AUTOMATIC MOTORCYCLE TYRE CHANGER







M39 ATV

STANDARD ACCESSORIES









Code	Electrical Supply	Description	
0-11613501/34	230V / 1Ph / 50Hz	M39 ATV Grey RAL 7016	
0-11613506/34	230V / 1Ph / 60Hz	M39 ATV Grey RAL 7016	
0-11613514/34	115V / 1Ph / 60Hz	M39 ATV Grey RAL 7016	

ACCESSORIES MOTORCYCLE TYRE CHANGERS M39 ATV

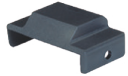
Image	Description	Code	
x6 	PPM Kit of 6 protections for shoe.	8-11600020	
	SR Wheel support kit.	8-11600116	
	PR Wheel support kit.	8-11600117	
x4 	UCA - Set of 4 motocross clamps.	8-11600118	
x4 	ATV A - ATV adaptors kit.	8-11600119	
	ATV C - ATV centring kit.	8-11600120	

ACCESSORIES MOTORCYCLE TYRE CHANGERS M39 ATV

Image	Description	Code	
	CKM - locking clamps kit (4 pcs).	8-11600121	
x4 	GKS - plastic protections kit.	8-11600122	
x4 	GK - Go-KART adaptors kit (4 pcs).	8-11600123	
	Tools holder.	8-11600124	
	Grease bucket 1 kg.	8-11600125	
	IG.P inflating gun, EC homologated	8-11600126	

S 41 E CROSS

Standard Accessories

x5



cod. 8-11100107

x10



cod. 8-11100106



cod. 8-11600126

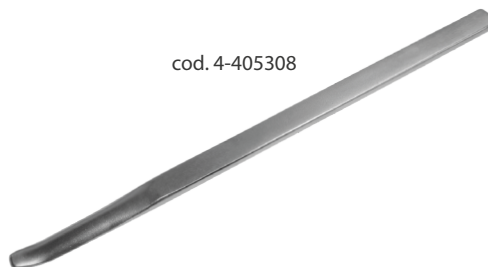

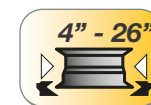
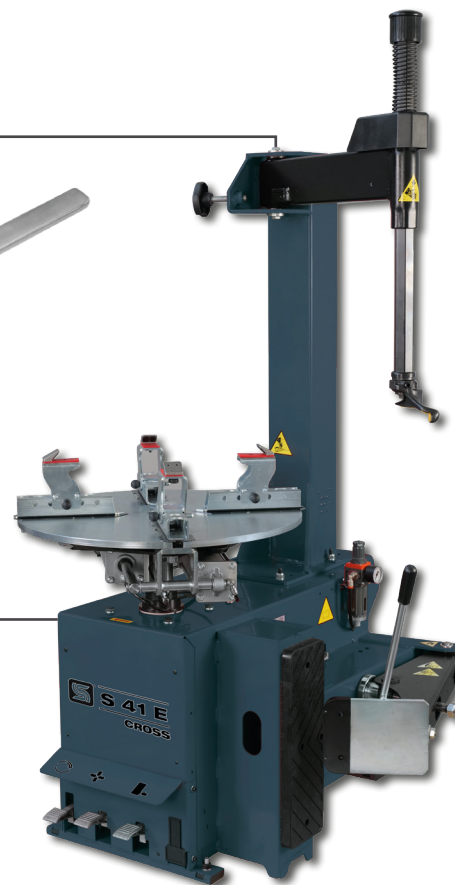

cod. 4-405308



Codice	Alimentazione	Descrizione	
0-11481101/34	400V/3Ph/50Hz	S 41 E CROSS	
0-11481102/34	230V/3Ph/50Hz	S 41 E CROSS	
0-11481103/34	230V/1Ph/50Hz	S 41 E CROSS	
0-11481104/34	230V/1Ph/60Hz	S 41 E CROSS	
0-11481105/34	115V/1Ph/60Hz	S 41 E CROSS	

ACCESSORIES MOTORCYCLE TYRE CHANGERS S 41 E CROSS

Image	Description	Code	
	Racing bike turntable <i>jaw kit 8" – 26"</i>	8-11100461	
	ATV turntable <i>jaw kit 5"-18"</i>	8-11100462	
	<i>Removable platform</i> for bike wheels	8-11100463	

MORE ACCESSORIES FOR MODEL S 41 E CROSS ARE AVAILABLE IN THE CAR TYRE CHANGER ACCESSORIES SECTION

TRADITIONAL SEMI-AUTOMATIC CAR TYRE CHANGER

S 41 E

STANDARD ACCESSORIES

x5



cod. 8-11100107

x10



cod. 8-11100106



cod. 8-11600126

cod. 4-405308

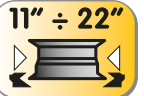

Code	Electrical Supply	Description
0-11472001/34	400V/3Ph/50Hz	S 41 E
0-11472002/34	200-230V/1Ph/50Hz	S 41 E
0-11472012/34	200-230V/1Ph/60Hz	S 41 E
0-11473001/34	400V/3Ph/50Hz	S 41 E GP
0-11473002/34	200-230V/1Ph/50Hz	S 41 E GP
0-11473004/34	115V/1Ph/60Hz	S 41 E GP
0-11472006/34	12 Volt	S 41 E 12V
0-11472005/34	AIR MOTOR	S 41 E Air Motor

S 41 E MAXI

STANDARD ACCESSORIES

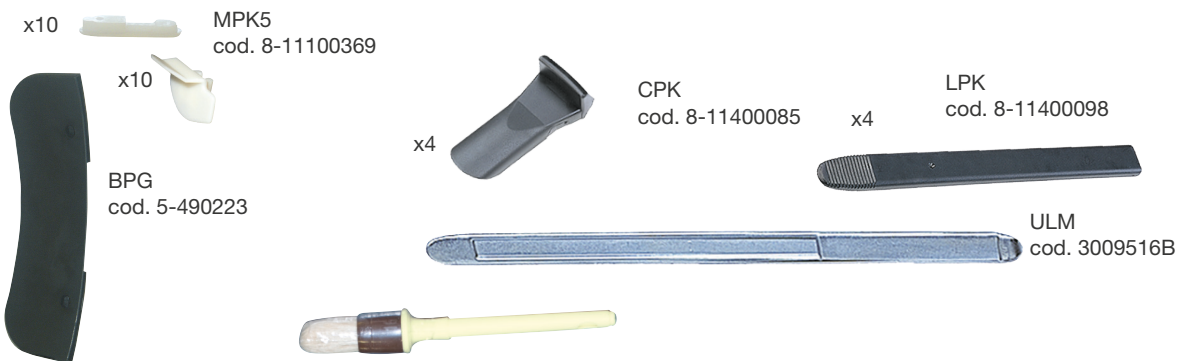

Code	Electrical Supply	Description
0-11461124/40	230V/1ph/50-60Hz	S 41E Maxi (FPI device included)

TRADITIONAL AUTOMATIC CAR TYRE CHANGER

S 42 E

STANDARD ACCESSORIES

x5



cod. 8-11100107

x10



cod. 8-11100106



cod. 8-11600126

cod. 4-405308



Code	Electrical Supply	Description
0-11474401/34	400V/3ph/50Hz	S42E 22"
0-11474402/34	230V/1ph/50Hz	S42E 22"
0-11474411/34	200-230V/3ph/60Hz	S42E 22"
0-11474412/34	230V/1ph/60Hz	S42E 22"
0-11474432/34	INV. 230/1ph/50-60Hz	S42E 22" 2V
0-11474441/34	2V 400/3ph/50Hz	S42E 22" 2V
0-11474451/34	2V 200-230V/3ph/60Hz	S42E 22" 2V
0-11474201/34	400V/3ph/50Hz	S42E 22" GP
0-11474202/34	230V/1ph/50Hz	S42E 22" GP
0-11474211/34	200-230V/3ph/60Hz	S42E 22" GP
0-11474212/34	230V/1ph/60Hz	S42E 22" GP
0-11474232/34	INV. 230/1ph/50-60Hz	S42E 22" GP 2V
0-11474241/34	2V 400/3ph/50Hz	S42E 22" GP 2V
0-11474251/34	2V 200-230V/3ph/60Hz	S42E 22" GP 2V

TRADITIONAL AUTOMATIC CAR TYRE CHANGER

S 43 - S 43 A

STANDARD ACCESSORIES

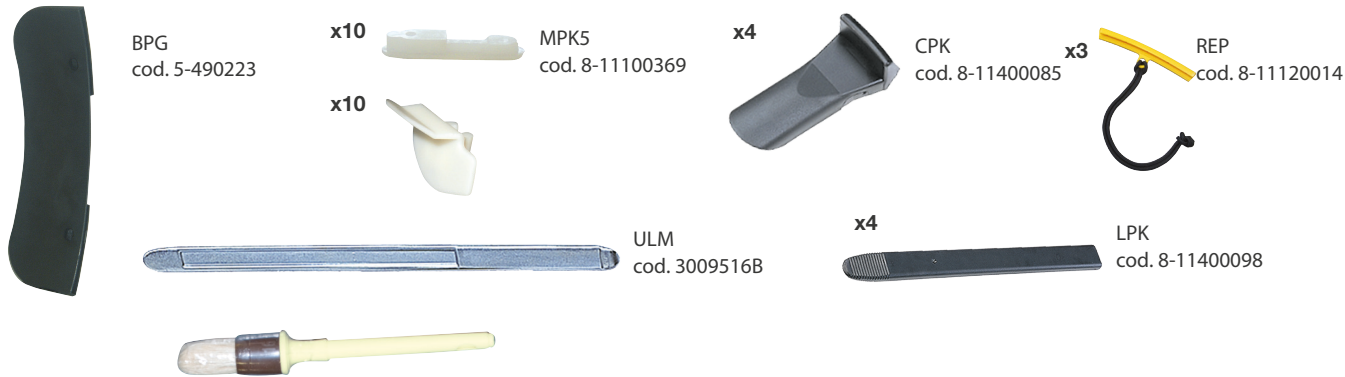

Code	Electrical Supply	Description
0-11463039/40	INV. 230V/1Ph/50-60Hz	S 43 24"
0-11463132/40	INV. 230V/1Ph/50-60Hz	S 43 24" GP (FPI device included)
0-11463134/40	INV.230V/1ph/50-60Hz	S43 A 24"
0-11463135/40	INV.230V/1ph/50-60Hz	S43 A 24" GP (FPI device included)

S 45 BASIC

STANDARD ACCESSORIES

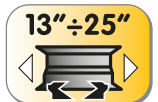
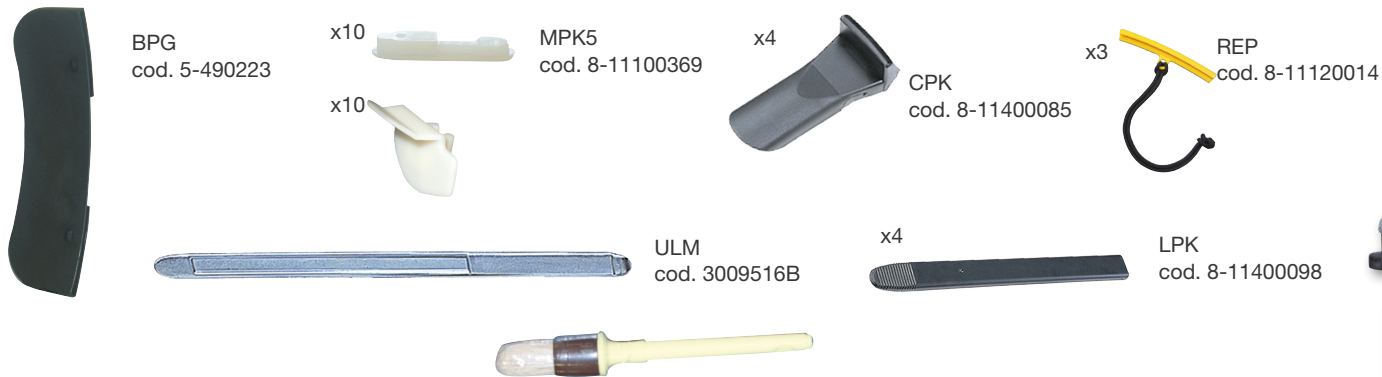

Code	Electrical Supply	Description	
0-11464010/AA	2V 400V/3Ph/50Hz	S 45 Basic RAL 1007	
0-11464010/BA	2V 400V/3Ph/50Hz	S 45 Basic RAL 3002	
0-11464010/CA	2V 400V/3Ph/50Hz	S 45 Basic RAL 5015	
0-11464112/AA	2V 400V/3Ph/50Hz	S 45 Basic GP RAL 1007	
0-11464112/BA	2V 400V/3Ph/50Hz	S 45 Basic GP RAL 3002	
0-11464112/CA	2V 400V/3Ph/50Hz	S 45 Basic GP RAL 5015	

TRADITIONAL AUTOMATIC CAR TYRE CHANGER

S 45

STANDARD ACCESSORIES

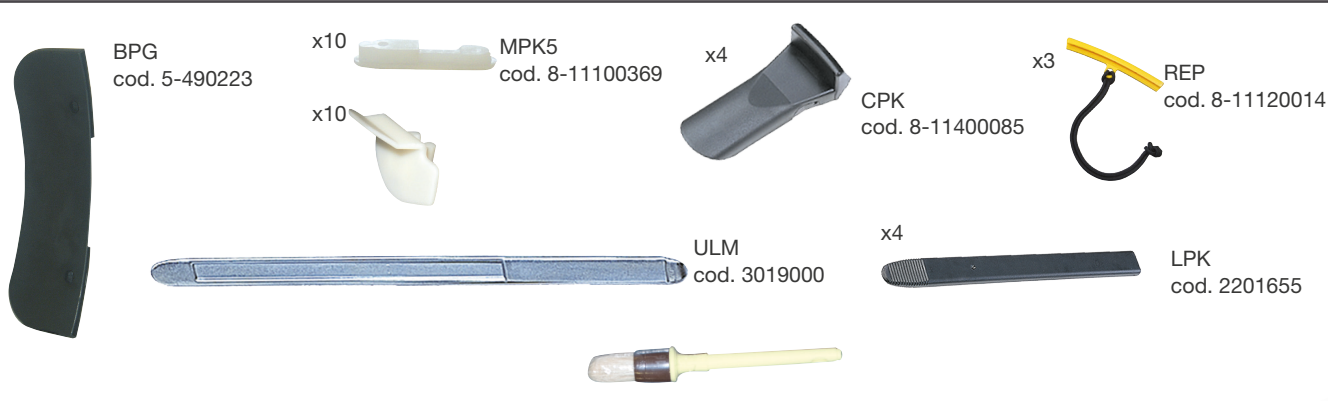

Code	Electrical Supply	Description	
0-11464025/40	INV.230V/1ph/50-60Hz	S45 24"	
0-11464115/40	INV.230V/1ph/50-60Hz	S45 24" GP (PO/ULGS device included)	

S 45 TOP



07/007

STANDARD ACCESSORIES

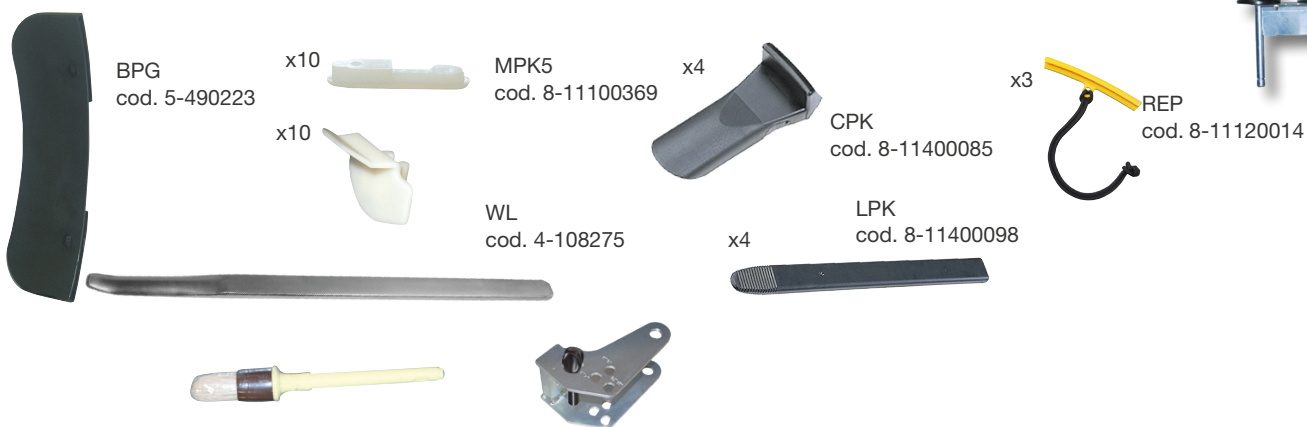

Code	Electrical Supply	Description
0-11464023/00	INV. 230/1ph/50-60Hz	S45 TOP with tilting-back BPT (PT250 included)
0-11464114/00	INV. 230/1ph/50-60Hz	S45 TOP GP with tilting-back BPT (PT250 included)

CAR TYRE CHANGER FOR MOBILE SERVICE

S 44 M



FOR MOBILE SERVICE

HELPER BPL
on request

STANDARD ACCESSORIES

bpg
cod. 5-490223



x4

x10

recommended

press heel helper left
cod. 8-11100399 - pbl
connection set
cod 8-11320005



bead press pliers
rft & wdk
cod. 801262417









bead press pliers
cod. 80143685



Code	Electrical Supply	Description	
0-11481001/40	12V	S44 MOBILE Dx 24" 12V	

ACCESSORIES FOR "TRADITIONAL" CAR TYRE CHANGERS

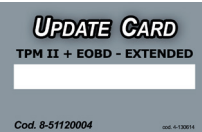
Image	Description	Code		S 41 Maxi	S 41 E Maxi	S 41E Cross	S 41E	S 42	S 42 E	S 43 - S 43GP 24"	S 45 Basic	S 45 - S 45Gp	S 45 TOP	S 44 M	
COMPLEMENTARY ACCESSORIES															
	TPM-02 Device for checking operation of TPMS sensors reader and programmer)	6015001300		O	O	-	O	O	O	O	O	O	O	O	
	OBD Kit	8-64500013		O	O	-	O	O	O	O	O	O	O	O	
	Kit TPM-02 PLUS (reader and programmer, kit OBD included)	6015001391		O	O	-	O	O	O	O	O	O	O	O	
<div style="display: flex; flex-wrap: wrap;"> <div style="width: 50%; text-align: center;">  <p>Cod. 8-5110029</p> </div> <div style="width: 50%; text-align: center;">  <p>Cod. 8-51120001</p> </div> <div style="width: 50%; text-align: center;">  <p>Cod. 8-51120003</p> </div> <div style="width: 50%; text-align: center;">  <p>Cod. 8-51120004</p> </div> </div>	Subscription 12M TPM-02 standard	8-51100029													
	Subscription 12M TPM-02 extended	8-51120003													
	Subscription 12M TPM-02 PLUS	8-51120001		O	O	-	O	O	O	O	O	O	O	O	
	Subscription 12M TPM-02 PLUS extended	8-51120004													



ACCESSORIES FOR "TRADITIONAL" CAR TYRE CHANGERS

Image	Description	Code		S 41 Maxi	S 41 E Maxi	S 41E Cross	S 41E	S 42	S 42 E	S 43 - S 43GP 24"	S 45 Basic	S 45 - S 45Gp	S 45 TOP	S 44 M
COMPLEMENTARY ACCESSORIES														
	Bluetooth printer.	6015001360		O	O	-	O	O	O	O	O	O	O	O

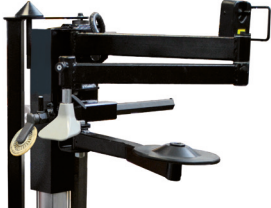
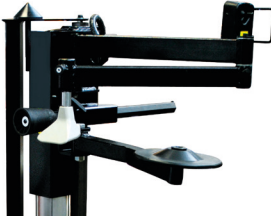

ACCESSORIES FOR "TRADITIONAL" CAR TYRE CHANGERS

Image	Description	Code											
			S 41 Maxi	S 41 E Maxi	S 41E Cross	S 41E	S 42	S 42 E	S 43 - S 43GP 24"	S 45 Basic	S 45 - S 45Gp	S 45 TOP	S 44 M
COMPLEMENTARY ACCESSORIES - BEAD LIFTING-PRESSING DEVICE													
	PT 150E Bead lifting-pressing device.	8-11100410	-	-	-	-	O	-	O	O	O	-	-
	PT230 complete kit, version with disc (S42 e S43), mounting kit included	8-11400332	-	-	-	-	O	-	O	-	-	-	-
	PT230 complete kit , standard version - roller (S42 e S43), mounting kit included	8-11400333	-	-	-	-	O	-	O	-	-	-	-
	PT230E complete kit , standard version - roller (S42E), mounting kit included	8-11400335	-	-	-	-	O	-	-	-	-	-	-

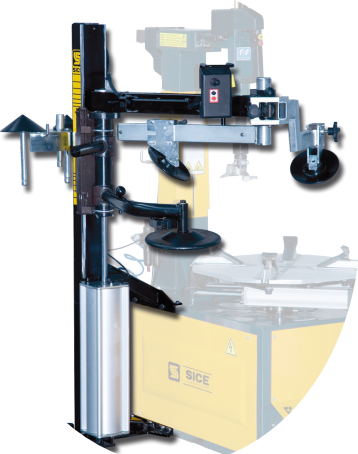
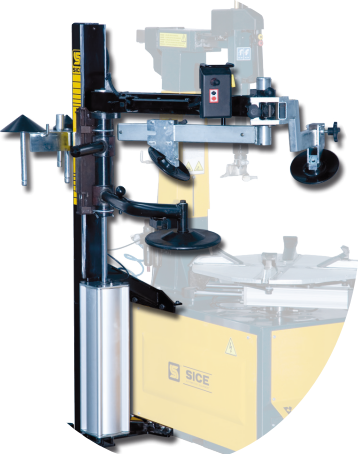
ACCESSORIES FOR "TRADITIONAL" CAR TYRE CHANGERS

Image	Description	Code		S 41 Maxi	S 41 E Maxi	S 41E Cross	S 41E	S 42	S 42 E	S 43 - S 43GP 24"	S 45 Basic	S 45 - S 45Gp	S 45 TOP	S 44 M
COMPLEMENTARY ACCESSORIES - BEAD LIFTING-PRESSING DEVICE														
	Kit cono premi-cerchio.	8-11100311		-	-	-	-	O	O	O	-	-	-	-
	Kit estensioni per premi-cerchio.	8-11100153		-	-	-	-	O	O	O	-	-	-	-
	PT 250 - Bead lifting-pressing device. Field installed.	8-11400139		-	-	-	-	O	-	O	O	O	-	-
	PT 250 - Bead lifting-pressing device. Factory installed.	8-11400140		-	-	-	-	O	-	O	O	O	●	-

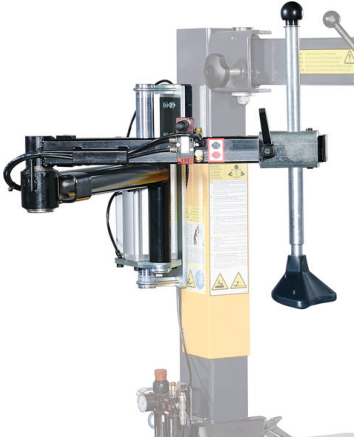





ACCESSORIES FOR "TRADITIONAL" CAR TYRE CHANGERS

Image	Description	Code		S 41 Maxi	S 41 E Maxi	S 41E Cross	S 41E	S 42	S 42 E	S 43 - S 43GP 24"	S 45 Basic	S 45 - S 45Gp	S 45 TOP	S 44 M
COMPLEMENTARY ACCESSORIES - BEAD LIFTING-PRESSING DEVICE														
	<p>PT 40 - Bead lifting-pressing device. Field installed</p>	8-11400215		O	-	-	-	-	-	-	-	-	-	-
	<p>PT 50 Multifunction helper</p>	8-11100343		-	-	-	-	O	O	O	-	-	-	-
	<p>Customization kit</p>	8-11100364		-	-	-	-	O	-	O	-	-	-	-
	<p>Customization kit for S 42 E</p>	8-11400331		-	-	-	-	-	O	-	-	-	-	-



ACCESSORIES FOR "TRADITIONAL" CAR TYRE CHANGERS

Image	Description	Code		S 41 Maxi	S 41 E Maxi	S 41E Cross	S 41E	S 42	S 42 E	S 43 - S 43GP 24"	S 45 Basic	S 45 - S 45Gp	S 45 TOP	S 44 M
COMPLEMENTARY ACCESSORIES - BEAD LIFTING-PRESSING DEVICE														
	BPL Helper SX.	8-11120032		-	O	O	O	-	O	-	-	-	-	-
	BPL Helper SX	8-11100399		-	-	-	-	-	-	-	-	-	-	O
	BPL connection kit	8-11320005		-	-	-	-	-	-	-	-	-	-	O





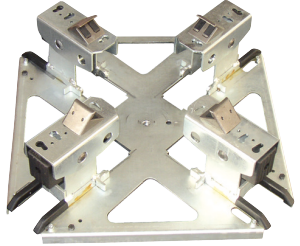

ACCESSORIES FOR "TRADITIONAL" CAR TYRE CHANGERS

Image	Description	Code												
			S 41 Maxi	S 41 E Maxi	S 41E Cross	S 41E	S 42	S 42 E	S 43 - S 43GP 24"	S 45 Basic	S 45 - S 45Gp	S 45 TOP	S 44 M	
TURNTABLE ADAPTORS														
 x4	AR10 Set of adaptors to reduce outside clamping capacity by 2".	8-11100043	O	O	-	-	O	-	O	O	O	O	-	
 x4	AR24 Set of adaptors to increase outside clamping capacity by 4".	8-11100041	O	O	-	-	O	O	O	O	O	O	O	
 x4	AR69 Set of adaptors to decrease outside clamping capacity by 4".	8-11100042	O	O	-	O	O	O	O	O	O	O	O	
 x4	AR46 Set of adaptors to increase outside clamping capacity by 4"/6".	8-11400276	O	O	-	-	O	-	O	O	O	O	-	
 x4	ARM Set of 4 motorcycle wheel adaptors.	8-11100036	O	O	-	O	O	O	O	O	O	O	O	
 x4	ARM-BD Set of 4 motorcycle wheel adaptors - Harley Davidson.	2201113A	O	O	-	O	O	O	O	O	O	O	O	







ACCESSORIES FOR "TRADITIONAL" CAR TYRE CHANGERS

Image	Description	Code		S 41 Maxi	S 41 E Maxi	S 41E Cross	S 41E	S 42	S 42 E	S 43 - S 43GP 24"	S 45 Basic	S 45 - S 45Gp	S 45 TOP	S 44 M
TURNTABLE ADAPTORS														
	<p>DBU26 Universal wheel clamping device for scooters, go-karts, motorcycles and Harley Davidson wheels. For convex rims and alloy rims up to 26". It makes same job as AR10 + AR24 + AR6 +ARM + ARM/BD + AR69 + ACB.</p>	8-11400100		O	O	-	O	O	O	O	O	O	O	O
 x4	<p>SKC Spare jaw protections.</p>	8-11400138		O	O	-	-	O	-	O	O	O	O	-
 x4	<p>SCK3 Spare guard kit for clamp.</p>	8-11400303		O	O	-	-	O	-	O	O	O	O	-







ACCESSORIES FOR "TRADITIONAL" CAR TYRE CHANGERS

Image	Description	Code											
			S 41 Maxi	S 41 E Maxi	S 41E Cross	S 41E	S 42	S 42 E	S 43 - S 43GP 24"	S 45 Basic	S 45 - S 45Gp	S 45 TOP	S 44 M
CONSUMABLES													
 x4	BPG N.4 Spare kit of grey plastic protections for new bead-breakers, produced from October 2004.	5-490223	●	●	-	-	●	-	●	●	●	●	-
 x6	Set of 6 black plastic protections for breaker blade.	801258383	-	-	-	○	-	○	-	-	-	-	○
	5 botton plastic inserts for head tool.	8-11100107	-	-	●	●	-	●	-	-	-	-	-
 x10	10 front plastic inserts for head tool.	8-11100106	-	-	●	●	-	●	-	-	-	-	-
 x20	OPK Spare kit of tool-head plastic protections.	2201199	○	○	-	-	○	-	○	○	○	○	-
IMMAGINE NON DISPONIBILE	Kit of 6 pieces of plastic protections for tyre lever for S 42 E	801246241	-	-	-	-	-	-	○	-	-	-	-
	6 plastic protections for code 8-11100120.	8-11100126	○	○	-	-	○	-	○	○	○	○	-
	BPR Bead pressing roller with spacer.	8-11400174	○	-	-	-	○	-	○	○	○	○	-





ACCESSORIES FOR "TRADITIONAL" CAR TYRE CHANGERS

Image	Description	Code		S 41 Maxi	S 41 E Maxi	S 41E Cross	S 41E	S 42	S 42 E	S 43 - S 43GP 24"	S 45 Basic	S 45 - S 45Gp	S 45 TOP	S 44 M
	PTR Rollertail (standard on PT 40)	8-11400290		O	O	O	O	O	O	O	O	O	O	O
	SPL3 Spare kit of plastic protections for alloy rims. (1 kit: 46 pcs.)	2201659		O	O	-	-	O	-	O	O	O	O	-
	MPK3 Spare kit of tool-head plastic protections.	8-11400096		●	●	-	-	●	-	●	●	●	●	-
	MPK4 Spare kit of tool-head plastic protections for TMN and TMN/CRU..	8-11400032		O	O	-	-	O	-	O	O	O	O	-
	MPK5 Spare kit of tool-head plastic protections for TAM	8-11100369		O	O	-	-	O	-	O	O	O	O	O
	MPK6 Protection kit for new scooters m/d head.	8-11100370		O	O	O	O	O	-	O	O	O	O	-
	CPK Spare kit of clamp plastic protections for alloy rims.	8-11400085		●	●	-	-	●	-	●	●	●	●	-





ACCESSORIES FOR "TRADITIONAL" CAR TYRE CHANGERS

Image	Description	Code		S 41 Maxi	S 41 E Maxi	S 41E Cross	S 41E	S 42	S 42 E	S 43 - S 43GP 24"	S 45 Basic	S 45 - S 45Gp	S 45 TOP	S 44 M
CONSUMABLES														
 x8	CPK PLUS Spare kit of clamp plastic protections with rubber insert for alloy rims.	8-11100358		O	O	-	-	O	-	O	O	O	O	-
 x12	Set of 12 protections for clamp, inside and outside.	8-11100044		O	O	-	O	O	O	O	O	O	O	O
 x10	RGT "Reglete" Mounting strips set for PAX tyres (for KPX).	2201887		O	O	-	-	O	O	O	O	O	O	O
	REP One kit of 3 rim edge plastic protections. Set of 3 pcs.	8-11120014		O	O	O	O	●	O	●	●	●	●	O
	REP Set of 10 kits of 3 rim edge plastic protections.	2201964		O	O	O	O	O	O	O	O	O	O	O
	REPS Rim edge plastic protections.	8-11120015		O	O	O	O	O	O	O	O	O	O	O
	SVD Double valve core installer - 1 piece, yellow.	2019932		O	O	O	O	O	O	O	O	O	O	O







ACCESSORIES FOR "TRADITIONAL" CAR TYRE CHANGERS

Image	Description	Code												
			S 41 Maxi	S 41 E Maxi	S 41E Cross	S 41E	S 42	S 42 E	S 43 - S 43GP 24"	S 45 Basic	S 45 - S 45Gp	S 45 TOP	S 44 M	
CONSUMABLES														
	VP Valve puller/core installer - 1 piece, yellow.	2019933	O	O	O	O	O	O	O	O	O	O	O	O
	PTS Plastic tool, yellow.	4-405310A	O	O	O	O	O	O	O	O	O	O	O	O
	PAR Wheel pad protection.	8-11400289	O	O	-	-	O	-	O	O	O	O	-	O
	SGG Tyre paste container (4 Kg) with brush.	8-11400034	O	O	O	O	O	O	O	O	O	O	O	O
	SG-WDK tyre paste container (3 Kg).	3-00708	O	O	O	O	O	-	O	O	O	O	O	O







ACCESSORIES FOR "TRADITIONAL" CAR TYRE CHANGERS

Image	Description	Code																						
			S 41 Maxi	S 41 E Maxi	S 41E Cross	S 41E	S 42	S 42 E	S 43 - S 43GP 24"	S 45 Basic	S 45 - S 45Gp	S 45 TOP	S 44 M											
MISCELLANEOUS																								
	SR80 Pneumatic lifter. Lifting capacity 80 kg. at 10 bar. Code 8-11400223 only for S48.	8-11400169	-	-	-	-	O	-	-	-	-	-	-	-	-	-								
		8-11400170	-	-	-	-	-	O	-	-	-	-	-	-	-	-								
		8-11400171	-	-	-	-	-	-	O	O	O	-	-	-	-	-								
		8-11400223 (for S48)	-	-	-	-	-	-	-	-	-	-	-	-	-	-								
	TPA-W Full Assembly plastic tool-head kit with adapter, for S40-S41-S42-S43-S45-S45Top-S48Top	8-11400329	O	O	-	-	O	-	O	O	O	O	O	O	O	O								
	TPA-W Full Assembly plastic tool-head kit with adapter, only for S41E and S42E	8-11400334	-	-	O	O	-	O	-	-	-	-	-	-	-	-								
	TPA-W single plastic tool-head (S40-S41-S42-S43-S45-S45Top-S48Top)	8-11400330	O	O	O	O	O	O	O	O	O	O	O	O	O	O								
	TMN Mounting/demounting tool-head for scooter wheels. Complete with plastic alloy rim protections. Starting from S/N SRC197168	8-11100378	O	O	O	O	O	-	O	O	O	O	O	O	O	O								
	Scooter mounting tool-head Up to S/N SRC197167	801252083	-	-	O	O	-	O	-	-	-	-	-	-	-	-								





ACCESSORIES FOR "TRADITIONAL" CAR TYRE CHANGERS

Image	Description	Code		S 41 Maxi	S 41 E Maxi	S 41E Cross	S 41E	S 42	S 42 E	S 43 - S 43GP 24"	S 45 Basic	S 45 - S 45Gp	S 45 TOP	S 44 M
MISCELLANEOUS														
	Quick release device with 2 adaptors for scooter mounting tool-head Up to S/N SRC197167	8-11100001		-	-	-	O	-	O	-	-	-	-	-
	CRU Universal quick exchange device for toolheads.	8-11400197		-	-	-	-	O	-	O	O	O	O	-
	TPA/CRU Spare plastic body for S48 too.	8-11400088		-	-	-	-	O	-	O	-	O	-	-
	UL Tyre lever L=500 mm.	3009516		●	●	O	O	●	-	●	●	●	O	●
 x4	LPK Spare kit for plastic lever protections, for UL.	8-11400098		●	●	O	O	●	-	●	●	●	O	●
	ULM Tyre lever for motorcycle wheels L=400 mm.	3019000		O	O	O	O	O	-	O	O	O	O	O
	BPC Plastic bead pressing clamp.	801435685		O	O	-	-	O	O	O	O	O	O	O

ACCESSORIES FOR "TRADITIONAL" CAR TYRE CHANGERS

Image	Description	Code												
			S 41 Maxi	S 41 E Maxi	S 41E Cross	S 41E	S 42	S 42 E	S 43 - S 43GP 24"	S 45 Basic	S 45 - S 45Gp	S 45 TOP	S 44 M	
MISCELLANEOUS														
	Sliding bead pressing clamp .	8-11100120	O	O	-	-	O	O	O	O	O	O	O	
	Motorcycle breaker blade for S 42	8-11120027	-	-	-	-	-	O	-	-	-	-	-	
	IG.P inflating gun, EC homologated	8-11600126	-	-	O	O	-	O	-	-	-	-	O	
	Lube bracket 1-5 Kg	8-11120095	-	-	O	O	-	-	-	-	-	-	-	
	Storage tray	8-11120092	-	-	O	O	-	O	-	-	-	-	-	
	PO/ULGS Storage tray with integrated pressure gauge and inflating pedal	8-11400307	O	O	-	-	O	-	O	O	O	●	-	

ACCESSORIES FOR "TRADITIONAL" CAR TYRE CHANGERS

Image	Description	Code		S 41 Maxi	S 41 E Maxi	S 41E Cross	S 41E	S 42	S 42 E	S 43 - S 43GP 24"	S 45 Basic	S 45 - S 45Gp	S 45 TOP	S 44 M
COMPLEMENTARY														
	PGA/CE ASTURO tyre inflating gun-&-gauge (CE norms) 10 bar	8-11100342		-	-	-	-	O	-	O	O	O	-	-
	PGM/CE MICHELIN tyre inflating gun-&-gauge (CE norms)	2305361		-	-	-	-	O	-	O	O	O	-	-
	GT40 Quick tubeless tyre inflation system retrofittable on all non GP version car tyre changers. (to be used with FPI)	8-11400240		O	O	-	-	O	-	O	O	O	O	-
	FPI Inflating system with pedal control and readout unit with deflating pushbutton (Standard on S 43 GP version)	8-11400218		●	●	-	-	O	-	O	O	O	-	-

"LEVERLESS" CAR TYRE CHANGER

S 45 TL



07/012

STANDARD ACCESSORIES

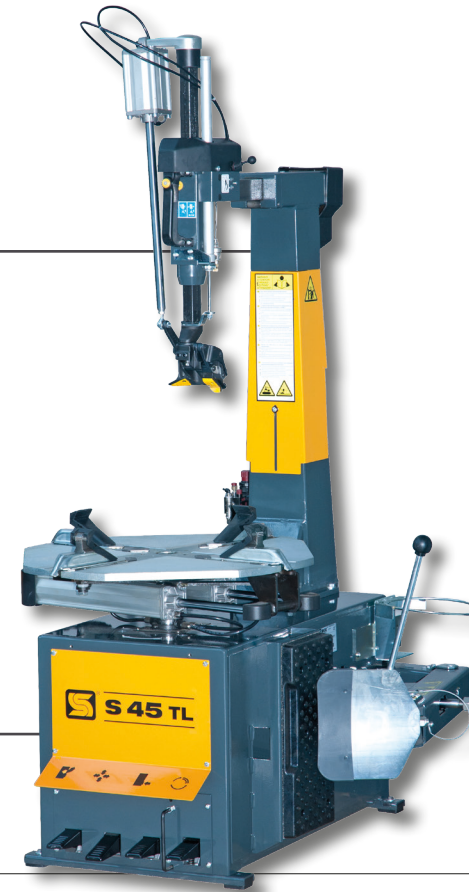
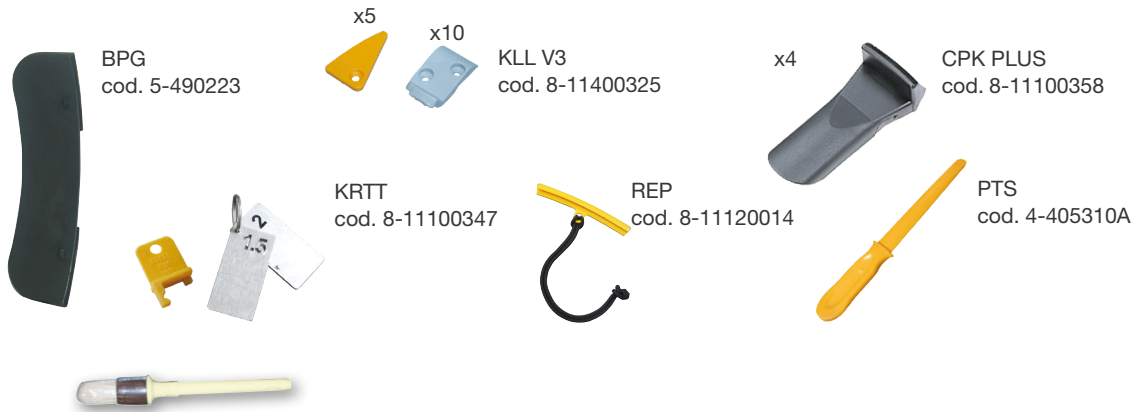

Code	Electrical Supply	Description
0-11467001/AA	INV. 230V/1Ph/50-60Hz	S 45 TL RAL 1007
0-11467001/BA	INV. 230V/1Ph/50-60Hz	S 45 TL RAL 3002
0-11467001/CA	INV. 230V/1Ph/50-60Hz	S 45 TL RAL 5015
0-11467001/DA	INV. 230V/1Ph/50-60Hz	S 45 TL RAL 9006
0-11467101/AA	INV. 230V/1Ph/50-60Hz	S 45 TL GP RAL 1007 (PO/ULGS included)
0-11467101/BA	INV. 230V/1Ph/50-60Hz	S 45 TL GP RAL 3002 (PO/ULGS included)
0-11467101/CA	INV. 230V/1Ph/50-60Hz	S 45 TL GP RAL 5015 (PO/ULGS included)
0-11467101/DA	INV. 230V/1Ph/50-60Hz	S 45 TL GP RAL 9006 (PO/ULGS included)

S 45 TL TOP

STANDARD ACCESSORIES

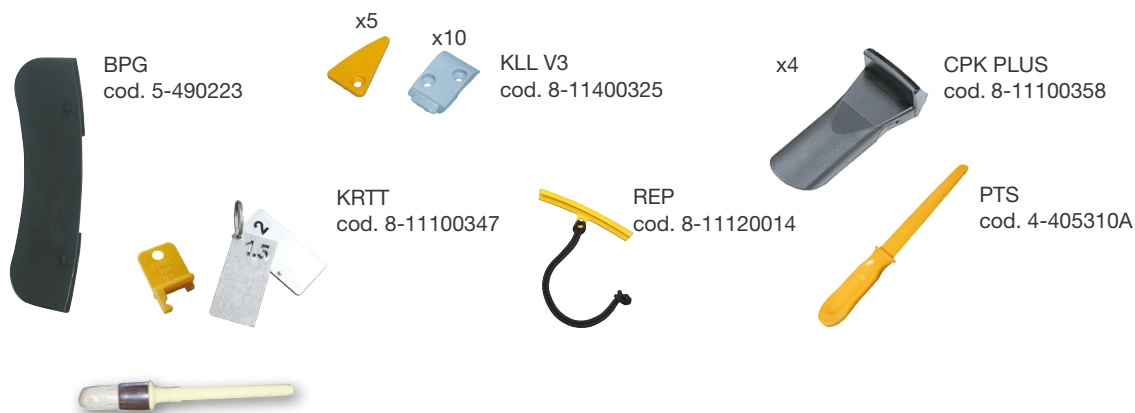

Code	Electrical Supply	Description
0-11467003/AA	INV. 230V/1Ph/50-60Hz	S 45 TL TOP with tilting-back BTP RAL 1007 (PO/ULGS included)
0-11467003/BA	INV. 230V/1Ph/50-60Hz	S 45 TL TOP with tilting-back BTP RAL 3002 (PO/ULGS included)
0-11467003/CA	INV. 230V/1Ph/50-60Hz	S 45 TL TOP with tilting-back BTP RAL 5015 (PO/ULGS included)
0-11467003/DA	INV. 230V/1Ph/50-60Hz	S 45 TL TOP with tilting-back BTP RAL 9006 (PO/ULGS included)
0-11467102/AA	INV. 230V/1Ph/50-60Hz	S 45 TL TOP GP with tilting-back BTP RAL 1007 (PO/ULGS included)
0-11467102/BA	INV. 230V/1Ph/50-60Hz	S 45 TL TOP GP with tilting-back BTP RAL 3002 (PO/ULGS included)
0-11467102/CA	INV. 230V/1Ph/50-60Hz	S 45 TL TOP GP with tilting-back BTP RAL 5015 (PO/ULGS included)
0-11467102/DA	INV. 230V/1Ph/50-60Hz	S 45 TL TOP GP with tilting-back BTP RAL 9006 (PO/ULGS included)

"LEVERLESS" CAR TYRE CHANGER

S 48 TL TOP



STANDARD ACCESSORIES

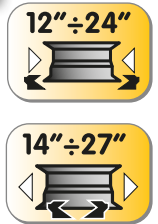
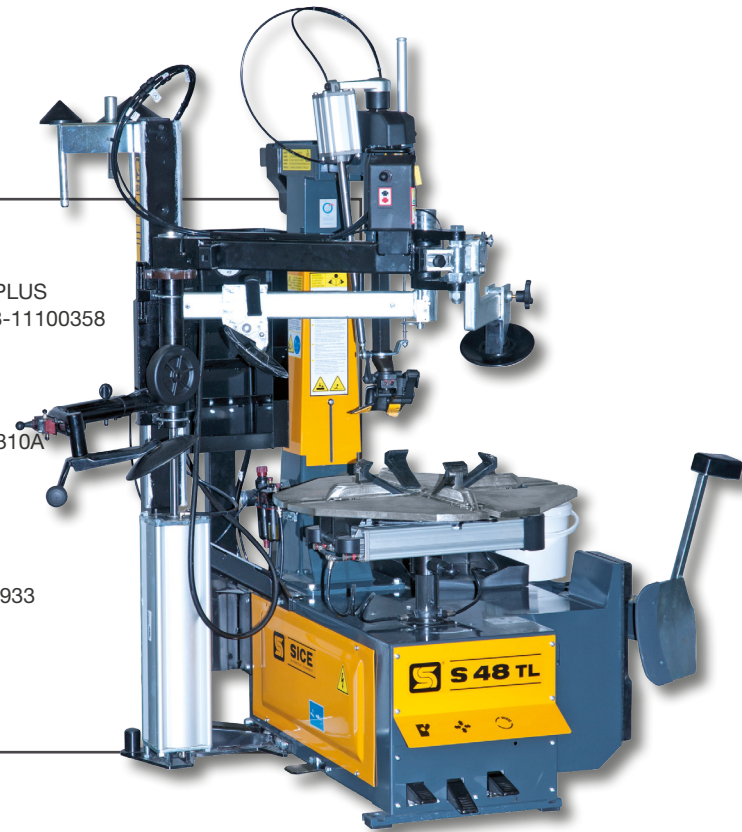
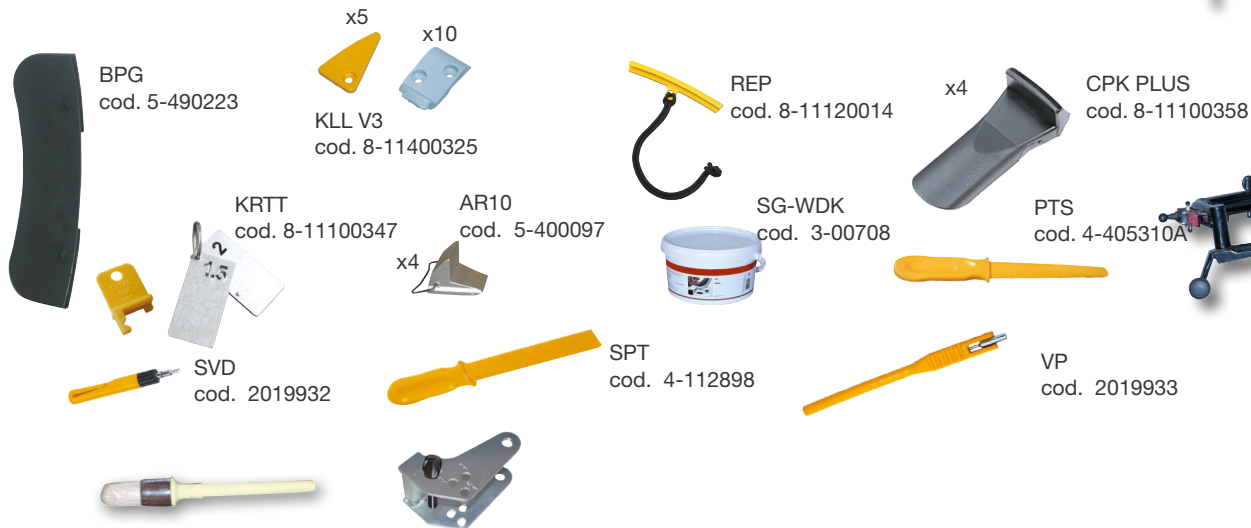

Code	Electrical Supply	Description	
0-11455017/AA	INV. 230V/1Ph/50-60Hz	S 48TL TOP with Power-Out RAL 1007	
0-11455017/BA	INV. 230V/1Ph/50-60Hz	S 48TL TOP with Power-Out RAL 3002	
0-11455017/CA	INV. 230V/1Ph/50-60Hz	S 48TL TOP with Power-Out RAL 5015	
0-11455017/DA	INV. 230V/1Ph/50-60Hz	S 48TL TOP with Power-Out RAL 9006	

"LEVERLESS" CAR TYRE CHANGER

S 200



07/016

STANDARD ACCESSORIES

x5
x10
KLL V3
cod.
8-11400325

PTS
cod. 4-405310A

KRTT
cod. 8-11100347

MPR
cod. 801262417

SVD
cod. 2019932

REP
cod. 8-11120014

REPS
cod. 8-11120015

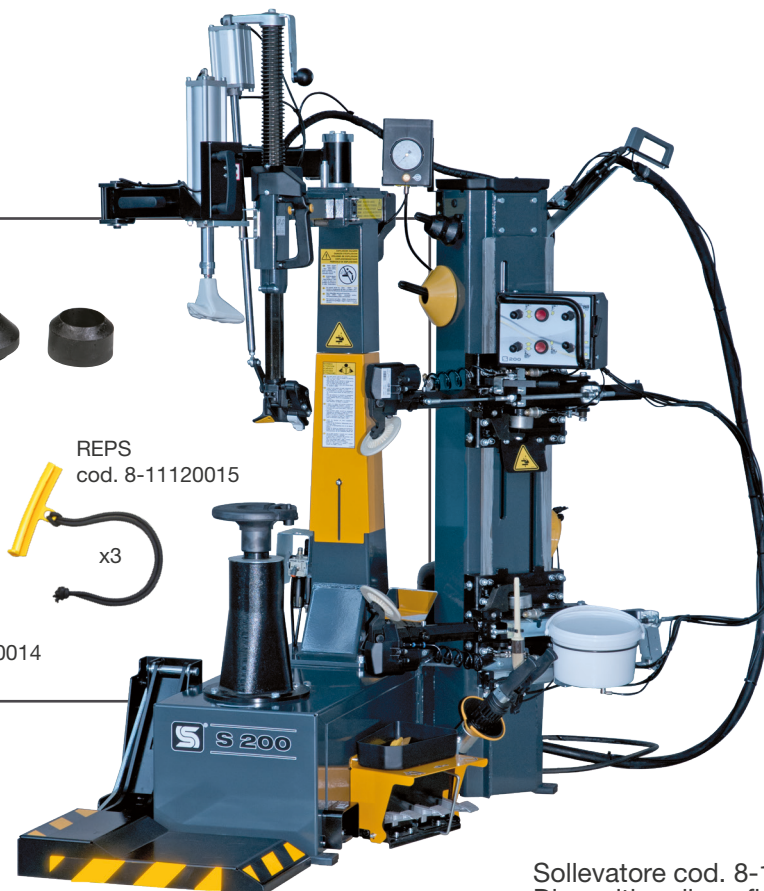

Sollevatore cod. 8-11100415 e
Dispositivo di gonfiaggio GT70 cod.
8-11100416 a richiesta

Code	Electrical Supply	Description
0-11478002/40	INV. 230V/1Ph/50-60Hz	S 200
0-11478004/40	INV. 230V/1Ph/50-60Hz	S 200 + wheel lifter

"LEVERLESS" CAR TYRE CHANGER

S 200 A



07/017

STANDARD ACCESSORIES

PTS
cod. 4-405310A



cod. 8-11400327



MPR
cod. 801262417



REP
cod. 8-11120014



REPS
cod. 8-11120015

SVD
cod. 2019932

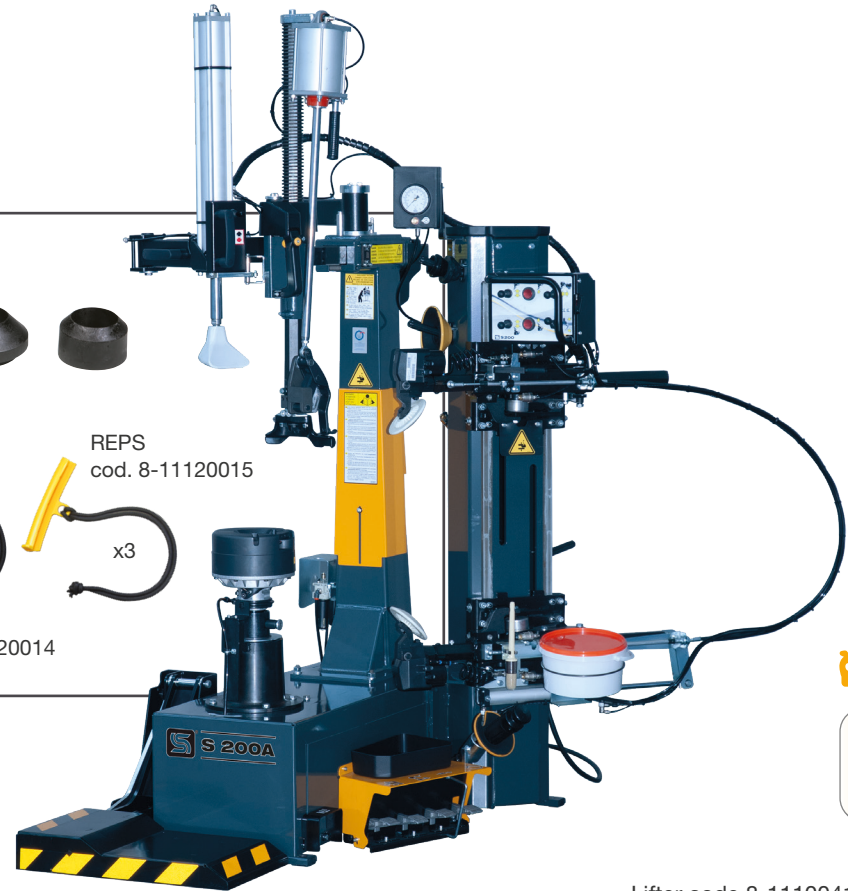

Lifter code 8-11100415 and GT70
inflating device
cod. 8-11100416 on request

Code	Electrical Supply	Description	
0-11478006/40	INV.230V/1ph/50-60Hz	S200A	
0-11478007/40	INV.230V/1ph/50-60Hz	S200A + wheel lifter	

"LEVERLESS" CAR TYRE CHANGER

SERIE S 300



07/001

STANDARD ACCESSORIES

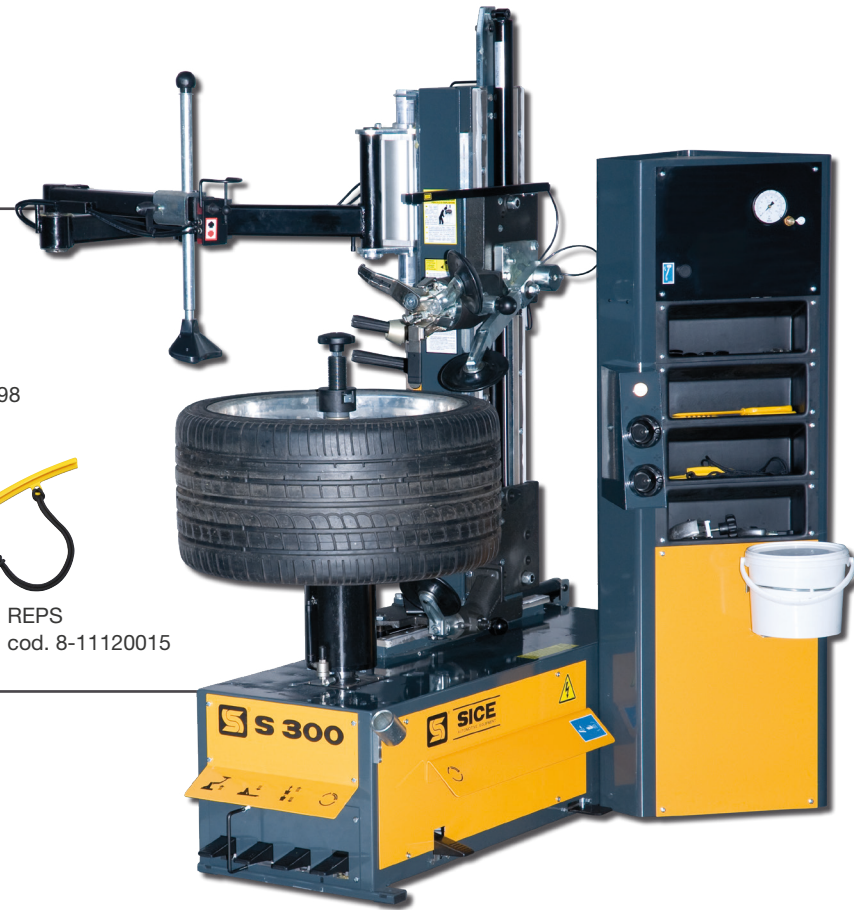

Code	Electrical Supply	Description	
0-11465023/00	230V/1ph/50-60Hz	S 300	
0-11465008	230V/1Ph/50-60Hz	S300 BMW RAL7016	

"LEVERLESS" CAR TYRE CHANGER

S 1000 EVOLUZIONE S.L.



07/015

STANDARD ACCESSORIES

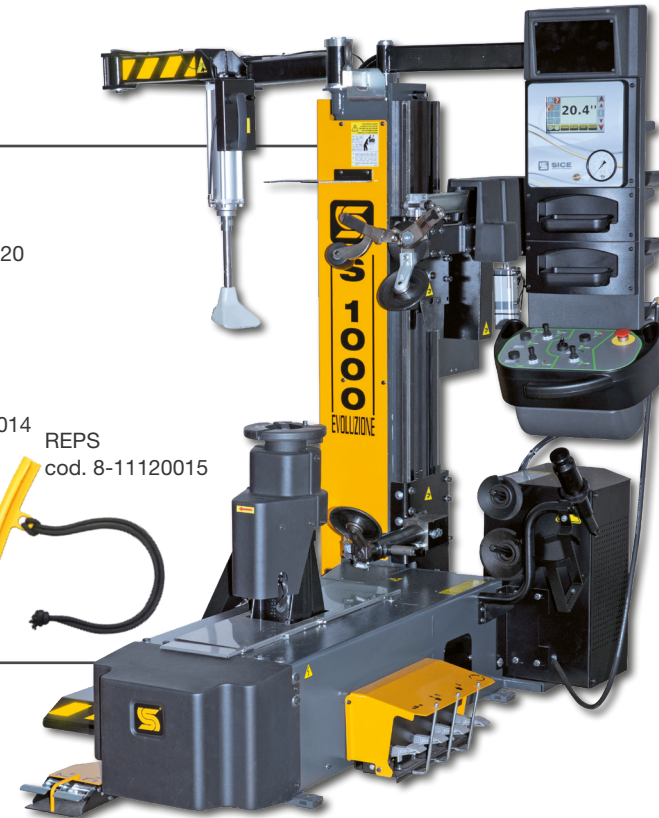
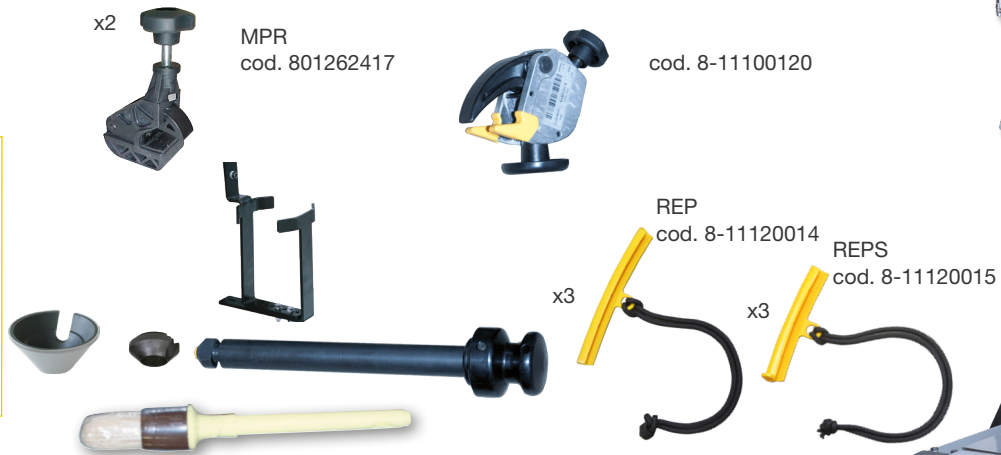

Code	Electrical Supply	Description	
0-11471001/40	200-230V/1Ph/50-60Hz	S1000 BASE version : bead presser and standard wheel lifter	
0-11471002/40	200-230V/1Ph/50-60Hz	S1000 VISUAL version : bead presser, standard wheel lifter and camera	
0-11471004/40	200-230V/1Ph/50-60Hz	S1000 PLUS version : bead presser, standard wheel lifter, camera and Inflatron	

S 1000 EVOLUZIONE P.L.



07/015

STANDARD ACCESSORIES

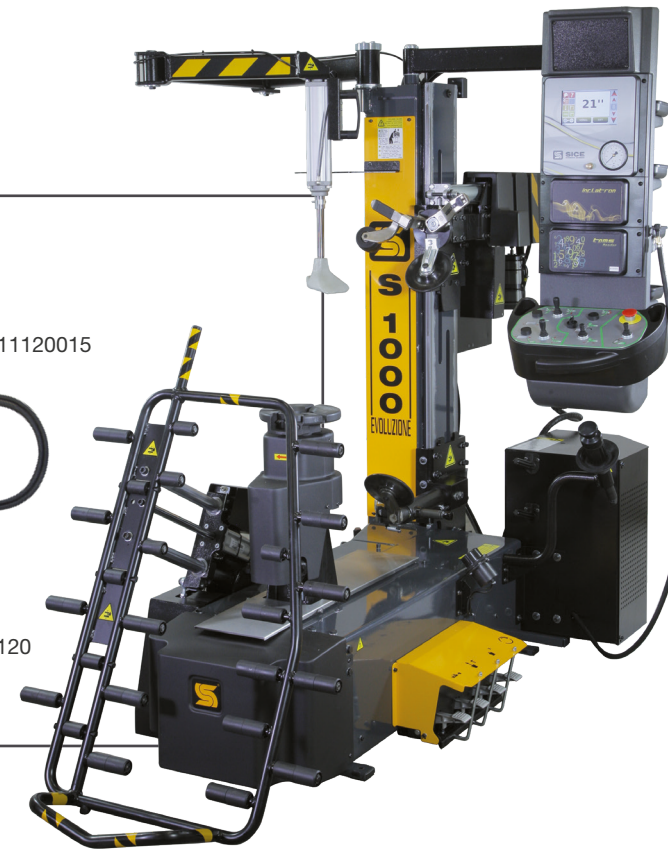

Code	Electrical Supply	Description
0-11471006/40	200-230V/1ph/50-60Hz	S1000 VISUAL P.L. version: bead presser, Premium wheel lifter and camera
0-11471007/40	200-230V/1ph/50-60Hz	S1000 PLUS P.L. version: bead presser, Premium wheel lifter, camera and Inflatron

“LEVERLESS” CAR TYRE CHANGER

S 1000 EVOLUZIONE A P.L.









07/015

STANDARD ACCESSORIES



Code	Electrical Supply	Description	
0-11471009/40	200-230V/1Ph/50-60Hz	S1000 BASE A P.L. version : bead presser, Premium wheel lifter, automatic demounting cycle	
0-11471010/40	200-230V/1Ph/50-60Hz	S1000 VISUAL A P.L. version: bead presser, Premium wheel lifter, automatic demounting cycle and camera	
0-11471008/40	200-230V/1Ph/50-60Hz	S1000 TOP A version: bead presser, Premium wheel lifter, camera, Inflatron, automatic demounting cycle, TPMS, tread probe and temperature probe	
0-11471011/64	200-230V/1Ph/50-60Hz	S1000 TOP A BMW version : bead presser, Premium wheel lifter, camera, Inflatron, automatic demounting cycle, TPMS, tread probe and temperature probe + Kit BMW	

ACCESSORIES FOR "LEVERLESS" CAR TYRE CHANGERS

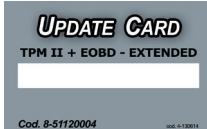
Image	Description	Code		S 45 TL	S 45 TL Top	S 48 TL Top	S 48 PL	S 200	S 200 A	S 1000 Evoluzione	S 300	S 300 M
SENSORS CONTROL SYSTEM												
	TPM-02 Device for checking operation of TPMS sensors reader and programmer)	6015001300		O	O	O	O	O	O	O	O	O
	OBD Kit	8-64500013		O	O	O	O	O	O	O	O	O
	Kit TPM-02 PLUS (reader and programmer, kit OBD included)	6015001391		O	O	O	O	O	O	O	O	O
<div style="display: flex; flex-wrap: wrap;"> <div style="width: 50%; text-align: center;">  <p>Cod. 8-51100029</p> </div> <div style="width: 50%; text-align: center;">  <p>Cod. 8-51120001</p> </div> <div style="width: 50%; text-align: center;">  <p>Cod. 8-51120003</p> </div> <div style="width: 50%; text-align: center;">  <p>Cod. 8-51120004</p> </div> </div>	Subscription 12M TPM-02 standard	8-51100029										
	Subscription 12M TPM-02 extended	8-51120003		O	O	O	O	O	O	O	O	O
	Subscription 12M TPM-02 PLUS	8-51120001										
	Subscription 12M TPM-02 PLUS extended	8-51120004										



ACCESSORIES FOR "LEVERLESS" CAR TYRE CHANGERS

Image	Description	Code		S 45 TL	S 45 TL Top	S 48 TL Top	S 48 PL	S 200	S 200 A	S 1000 Evoluzione	S 300	S 300 M
SENSORS CONTROL SYSTEM												
	Bluetooth <i>printer</i> .	6015001360		O	O	O	O	O	O	O	O	O



ACCESSORIES FOR “LEVERLESS” CAR TYRE CHANGERS

Image	Description	Code		S 45 TL	S 45 TL Top	S 48 TL Top	S 48 PL	S 200	S 200A	S 1000 Evoluzione	S 300	S 300 M
BEAD PRESSING SYSTEM												
	PT250TL Bead lifting-pressing device for “Leverless” tool-head tyre changer - Field Installed.	8-11100319		O	-	-	-	-	-	-	-	-
	PT250TL Bead lifting-pressing device for “Leverless” tool-head tyre changer - Factory Installed.	8-11100320		O	●	-	-	-	-	-	-	-





ACCESSORIES FOR "LEVERLESS" CAR TYRE CHANGERS

Image	Description	Code		S 45 TL	S 45 TL Top	S 48 TL Top	S 48 PL	S 200	S 200A	S 1000 Evoluzione	S 300	S 300 M
TURNTABLE ADAPTORS												
 x4	AR10 Set of adaptors to reduce outside clamping capacity by 2".	8-11100043		-	-	●	-	-	-	-	-	-
 x4	AR24 Set of adaptors to increase outside clamping capacity by 4".	8-11100041		O	O	O	-	-	-	-	-	-
 x4	AR69 Set of adaptors to decrease outside clamping capacity by 4".	8-11100042		O	O	O	-	-	-	-	-	-



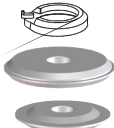
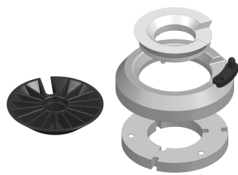

ACCESSORIES FOR "LEVERLESS" CAR TYRE CHANGERS

Image	Description	Code		S 45 TL	S 45 TL Top	S 48 TL Top	S 48 PL	S 200	S 200 A	S 1000 Evoluzione	S 300	S 300 M
WHEEL LIFTER												
	SR300 Air-operated wheel lifter capacity 100 Kg.	8-11400178		-	-	-	-	-	-	O	O	
	SR80 Air-operated lifter. Kg. 80 lifting capacity at 10 bar.	8-11400171		O	O	-	-	-	-	-	-	-
	Air-operated wheel lifter capacity 80 Kg.	8-11100415		-	-	-	-	O	O	-	-	-

ACCESSORIES FOR "LEVERLESS" CAR TYRE CHANGERS

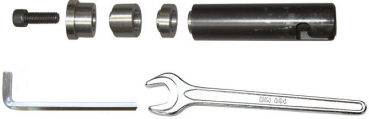
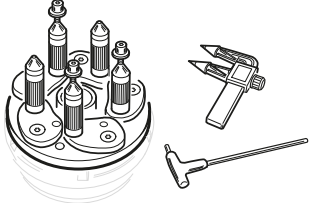
Image	Description	Code		S 45 TL	S 45 TL Top	S 48 TL Top	S 48 PL	S 200	S 200 A	S 1000 Evoluzione	S 300	S 300 M
CLAMPING DEVICE												
	Special adapter kit for high van rims (/H=6400)	8-15100026		-	-	-	-	-	-	O	-	-
	KCF Kit for light commercial vehicles.	8-11100361		-	-	-	-	-	-	-	O	O
	Kit for wide tire (h=28+22 mm) and light commercial vehicles (automatic locking) Compatible hub hole diameter from 130 to 180 mm	8-11100460		-	-	-	-	-	O	O	-	-
	Kit for wide tire (h=28+22 mm) and light commercial vehicles (manual locking) Compatible hub hole diameter from 130 to 180 mm	8-11100417		-	-	-	-	O	-	-	-	-
	KRC Universal flange for special rims.	8-11100087		-	-	-	-	O	-	O	-	-
	KRC Universal flange for special rims	8-11100038		-	-	-	-	-	O	-	-	-
	FRF Universal flange for reverse rim wheels. Pin extension 120mm	8-11400209		-	-	-	-	-	-	-	O	O
	120mm pins extension kit (BMW)	8-11100448		-	-	-	-	-	-	-	O	O

ACCESSORIES FOR "LEVERLESS" CAR TYRE CHANGERS

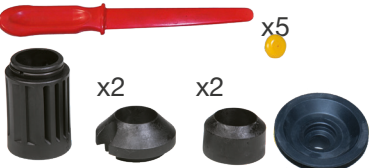
Image	Description	Code		S 45 TL	S 45 TL Top	S 48 TL Top	S 48 PL	S 200	S 200 A	S 1000 Evoluzione	S 300	S 300 M
CLAMPING DEVICE												
	MFC Additional kit for handling blind rims together with FRF adaptor.	8-11400210		-	-	-	-	-	-	○	○	
	Reverse wheel flange (maximum wheelbase 183 mm). Extensions H = 100 mm	8-11100039		-	-	-	-	○	○	○	-	-
 <p>x3</p>	KC300 Set of 3 centering cones.	8-11100298		-	-	-	●	-	-	-	●	●
 <p>x3</p>	KP300 Kit of protections for cones.	8-11100297		-	-	-	●	-	-	-	●	●
 <p>x5 x2 x2 x3</p>	Protections kit for manual locking	8-11100400		-	-	-	-	○	-	-	-	-
 <p>x5 x2 x2</p>	Protections kit for automatic locking	8-11100401		-	-	-	-	○	-	-	-	-
 <p>x5 x2 x2</p>	Protection kit for automatic locking	8-11100412		-	-	-	-	-	-	●	-	-







ACCESSORIES FOR "LEVERLESS" CAR TYRE CHANGERS

Image	Description	Code	S 45 TL	S 45 TL Top	S 48 TL Top	S 48 PL	S 200	S 200 A	S 1000 Evoluzione	S 300	S 300 M
-------	-------------	------	---------	-------------	-------------	---------	-------	---------	-------------------	-------	---------

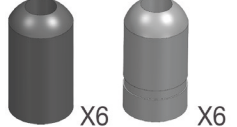

CLAMPING DEVICE

<p>Cerchi ciechi / Close centre rim </p> <p>Cerchi rovesci / Reverse rim </p>		NOT standard wheel kit.	8-11100110	-	-	-	-	-	O	-	-
38	Ring nut	4-102377									
39	Columns with locking device	5-102721									
40	Columns with locking device	5-102720									
36	Universal flange	5-102421									
41	Rim fixing screw	361647									
42	Rim fixing ring nut	361648									
43	Exagonal bar	4-102372									
44	Connecting rod	4-107023									
35	Hole detector	441286									
60	Fixing screw for connecting rod	4-101250									



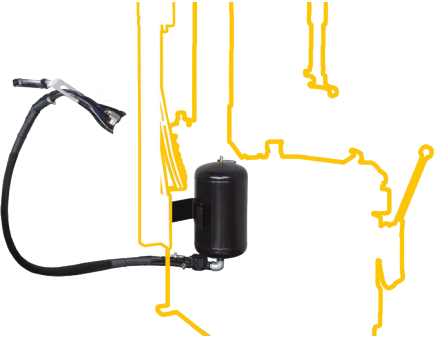

ACCESSORIES FOR "LEVERLESS" CAR TYRE CHANGERS

Image	Description	Code											
			S 45 TL	S 45 TL Top	S 48 TL Top	S 48 PL	S 200	S 200 A	S 1000 Evoluzione	S 300	S 300 M		
CLAMPING DEVICE													
	KE20 Set of 6 "short" extensions. H = 80 mm	8-11100244	-	-	-	-	O	O	O	-	-		
	KE40 Set of 6 "extra short" extensions. H = 60 mm	8-11100245	-	-	-	-	O	O	O	-	-		
	KE25 Set of 6 "long" extensions. H = 125 mm	8-11100246	-	-	-	-	O	O	O	-	-		
	KPC12 Set of 12 plastic guards for extensions.	8-11100284	-	-	-	-	O	O	O	-	-		
	KEA28 Set of 6 spherical extensions for new audi type rims	8-11100291	-	-	-	-	O	O	O	-	-		
	KE28 Extension kit for reverse wheel flange, flange for close centre rims and non standard wheel kit. H + 23 mm / Diam. 25 mm	8-11100046	-	-	-	-	O	O	O	-	-		





ACCESSORIES FOR "LEVERLESS" CAR TYRE CHANGERS

Image	Description	Code		S 45 TL	S 45 TL Top	S 48 TL Top	S 48 PL	S 200	S 200 A	S 1000 Evoluzione	S 300	S 300 M
MISCELLANEOUS												
	GT70 Inflating unit for S 200	8-11100416		-	-	-	-	O	O	-	-	-
	GT300 tubeless inflating unit.	8-11400179		-	-	-	-	-	-	-	O	O
	GT40 Quick tubeless tyre inflation system retrofittable on all non GP version car tyre changers. (to be used with FPI)	8-11400240		O	O	O	O	-	-	-	-	-



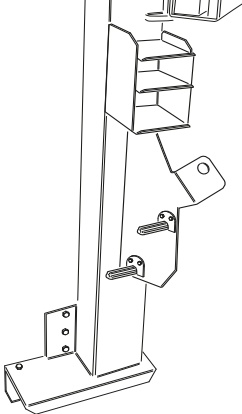

ACCESSORIES FOR "LEVERLESS" CAR TYRE CHANGERS

Image	Description	Code										
			S 45 TL	S 45 TL Top	S 48 TL Top	S 48 PL	S 200	S 200 A	S 1000 Evoluzione	S 300	S 300 M	
MISCELLANEOUS												
	T.I. Tyre inflating kit.	8-11100404										
	T.I. ASME tyre inflating kit (for USA and Canada only)	8-15100038	-	-	-	-	-	-	O	-	-	
	FPI Inflating system with pedal control and readout unit with deflating pushbutton.	8-11400218	O	-	-	-	-	-	-	-	-	
	PGA/CE ASTURO tyre inflating gun-&-gauge (CE norms) 10 bar.	8-11100342	O	-	-	-	-	-	-	-	-	
	PGM/CE MICHELIN tyre inflating gun-&-gauge (CE norms).	2305361	O	-	-	-	-	-	-	-	-	
	BPC Plastic bead pressing clamp.	801435685	O	-	O	O	O	O	O	O	O	





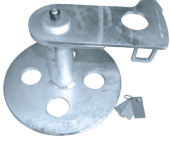

ACCESSORIES FOR "LEVERLESS" CAR TYRE CHANGERS

Image	Description	Code										
			S 45 TL	S 45 TL Top	S 48 TL Top	S 48 PL	S 200	S 200 A	S 1000 Evoluzione	S 300	S 300 M	
MISCELLANEOUS												
	SAC Accessories holder.	8-11100159	-	-	-	-	-	-	-	-	-	-
	MPR Bead pressing clamp for Run Flat tyres.	801262417	O	O	O	O	●	●	●	O	O	
	TPA-W Single plastic tool head	8-11400327	-	-	-	-	-	O	-	-	-	
	Sliding bead pressing clamp .	8-11100120	O	O	O	O	O	O	●	O	O	



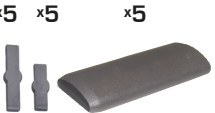

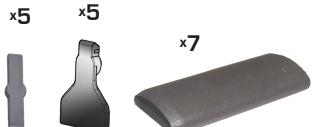

ACCESSORIES FOR "LEVERLESS" CAR TYRE CHANGERS

Image	Description	Code		S 45 TL	S 45 TL Top	S 48 TL Top	S 48 PL	S 200	S 200 A	S 1000 Evoluzione	S 300	S 300 M
MISCELLANEOUS												
	KOF50 Additional spacer for wheels with reverse rims.	8-11400181		-	-	-	-	-	-	●	●	
	KPX 300 Pax wheel kit, valid from serial number IHA725054	8-11120051		-	-	-	-	-	-	○	○	
	DRT Template kit for head tool adjustment.	8-11100125		-	-	-	-	-	-	-	-	-
	MAT TC Mobile Accessories Trolley	8-11100456		-	-	-	-	○	○	○	○	○







ACCESSORIES FOR "LEVERLESS" CAR TYRE CHANGERS

Image	Description	Code		S 45 TL	S 45 TL Top	S 48 TL Top	S 48 PL	S 200	S 200A	S 1000 Evoluzione	S 300	S 300 M
 <p>x5 x10</p>	<p>KLL Spare kit of leverless tool head plastic protections.</p>	8-11400293		●	●	●	●	-	-	-	-	-
 <p>x5 x10</p>	<p>KLL V3 Spare kit of V3 leverless tool head plastic protections From machine with serial number IMA743101.</p>	8-11400325		●	●	●	●	●	-	-	-	-
	<p>PTR Rollertail (standard on PT 40).</p>	8-11400290		○	○	○	○	-	-	-	-	-
 <p>x5 x5 x5</p>	<p>KPU Spare tool plastic protection kit. S 300 Until s.n. IQB780317</p>	8-11400212		-	-	-	-	-	-	-	○	○
 <p>x3</p>	<p>KPUL Spare tool plastic protection kit.</p>	8-11120035		-	-	-	-	-	-	○	○	○
 <p>x5 x5 x7</p>	<p>TH Spare tool plastic protection kit. S 300 from s.n. IQB780318</p>	8-11120036		-	-	-	-	-	-	○	○	○
 <p>x4</p>	<p>BPG Spare kit of grey plastic protections for new bead-breakers, produced from October 2004.</p>	5-490223		●	●	●	●	-	-	-	-	-

ACCESSORIES FOR "LEVERLESS" CAR TYRE CHANGERS

ACCESSORIES FOR "LEVERLESS" CAR TYRE CHANGERS				S 45 TL	S 45 TL Top	S 48 TL Top	S 48 PL	S 200	S 200A	S 1000 Evoluzione	S 300	S 300 M
Image	Description	Code										
MISCELLANEOUS												
 x8	CPK Spare kit of clamp plastic protections for alloy rims.	8-11400085		O	O	O	-	-	-	-	-	-
 x8	CPK PLUS Spare kit of clamp plastic protections with rubber insert for alloy rims.	8-11100358		●	●	●	-	-	-	-	-	-
 x12	Set of 12 protections for clamp, inside and outside.	8-11100044		O	O	O	-	-	-	-	-	-
	REP One kit of 3 rim edge plastic protections. Set of 3 pcs.	8-11120014		●	●	●	●	●	●	●	-	-
	REP Set of 10 kits of 3 rim edge plastic protections.	2201964		O	O	O	O	O	O	O	-	-
	REPS Rim edge plastic protections.	8-11120015		-	-	-	-	●	●	●	●	●
	SVD Double valve core installer - 1 piece, yellow.	2019932		O	O	●	●	●	●	O	●	●

ACCESSORIES FOR "LEVERLESS" CAR TYRE CHANGERS

				S 45 TL	S 45 TL Top	S 48 TL Top	S 48 PL	S 200	S 200A	S 1000 Evoluzione	S 300	S 300 M
Image	Description	Code										
MISCELLANEOUS												
	VP Valve puller/core installer - 1 piece, yellow.	2019933		O	O	●	●	O	O	O	●	●
	PTS Plastic tool, yellow.	4-405310A		●	●	●	●	●	●	●	●	●
	6 plastic protections for code 8-11100120.	8-11100126		O	O	O	O	O	O	O	O	O
	PAR Wheel pad protection.	8-11400289		O	O	O	O	-	-	-	-	-
	SGG Tyre paste container (4 Kg) with brush.	8-11400034		O	O	O	O	O	O	O	O	O
	SG-WDK tyre paste container (3,5 Kg).	3-00708		O	O	●	●	O	O	O	●	●

SEMI-AUTOMATIC TRUCK TYRE CHANGER

S 52 A

STANDARD ACCESSORIES



BBR
cod. 801289439



UB
cod. 801289440



PC
cod. 2192441



LA
cod. 801217615

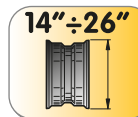
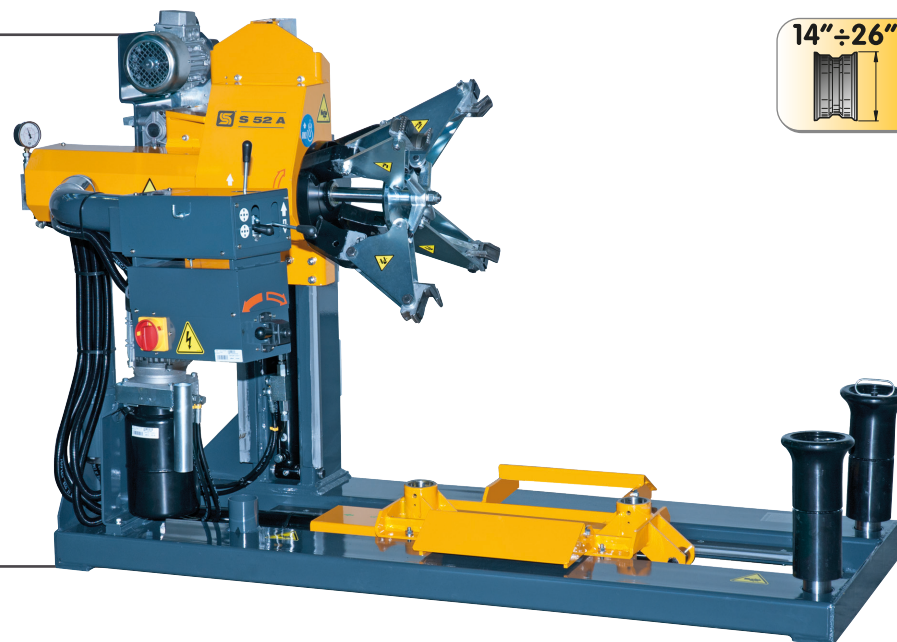

Code	Electrical Supply	Description	
0-12447046/40	400V/3Ph/50Hz	S 52 A	
0-12447047/40	230V/3Ph/60Hz	S 52 A	
0-12447048/40	230V/1Ph/50Hz	S 52 A	
0-12447049/40	230V/1Ph/60Hz	S 52 A	

SEMI-AUTOMATIC TRUCK TYRE CHANGER

S 53

STANDARD ACCESSORIES



PC
cod. 219244I



LC
cod. 801417620



LA
cod. 801217615

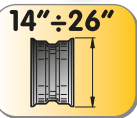
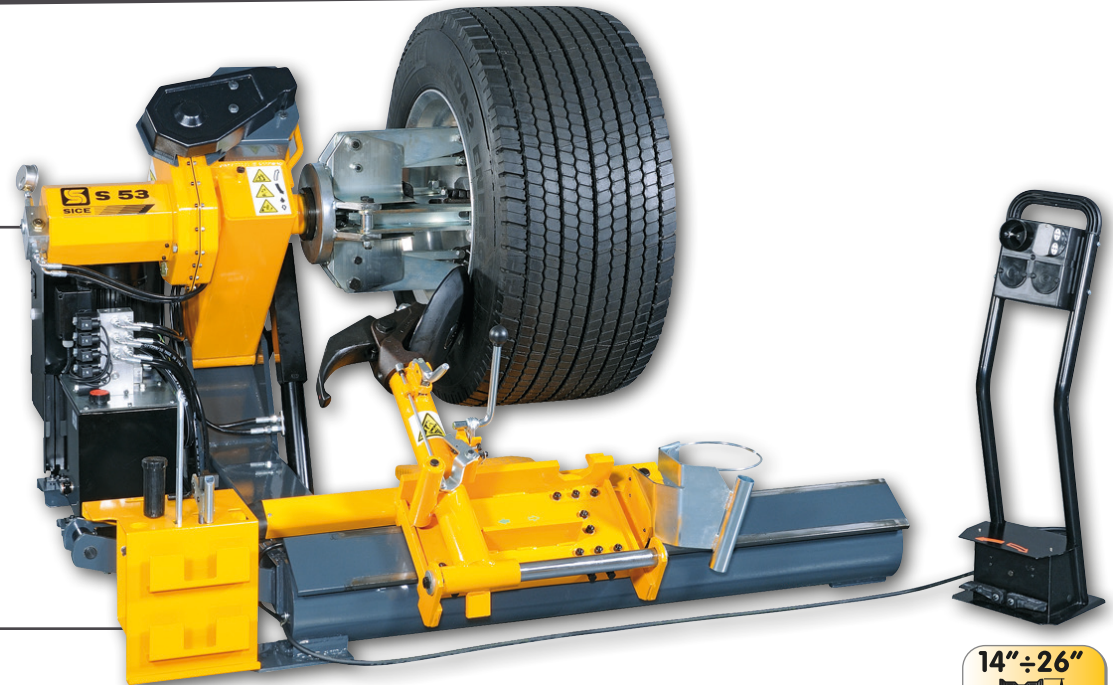

Code	Electrical Supply	Description	
0-12423008/A	400V/3Ph/50Hz	S 53 RAL 1007	
0-12423008/B	400V/3Ph/50Hz	S 53 RAL 3002	
0-12423008/C	400V/3Ph/50Hz	S 53 RAL 5015	
0-12423009/A	230V/3Ph/50Hz	S 53 RAL 1007	
0-12423009/B	230V/3Ph/50Hz	S 53 RAL 3002	
0-12423009/C	230V/3Ph/50Hz	S 53 RAL 5015	
0-12423010/A	400V/3Ph/60Hz	S 53 RAL 1007	
0-12423011/A	230V/3Ph/60Hz	S 53 RAL 1007	
0-12423012/A	230V/1Ph/50Hz	S 53 RAL 1007	
0-12423013/A	230V/1Ph/60Hz	S 53 RAL 1007	

SEMI-AUTOMATIC TRUCK TYRE CHANGER

S 54

STANDARD ACCESSORIES

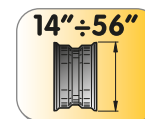
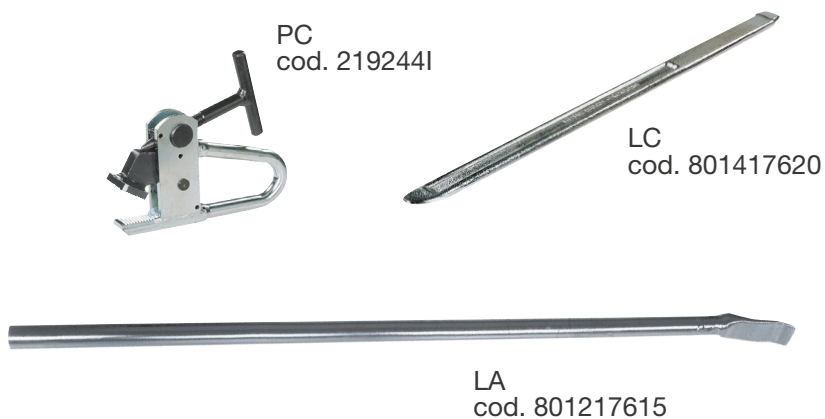

Code	Electrical Supply	Description
0-12400201/40	400V/3Ph/50Hz	S 54 RAL 1007
0-12400202/40	230V/3Ph/60Hz	S 54 RAL 1007
0-12400203/40	400V/3Ph/60Hz	S 54 RAL 1007
0-12400204/40	230V/3Ph/50Hz	S 54 RAL 1007
0-12400205/40	200V/3Ph/50Hz	S 54 RAL 1007 - Japan version

SEMI-AUTOMATIC TRUCK TYRE CHANGER

S 54 A

STANDARD ACCESSORIES

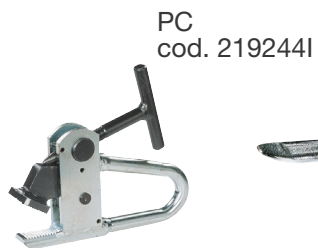

Code	Electrical Supply	Description
0-12400301/40	400V/3Ph/50Hz	S 54 A RAL 1007
0-12400302/40	230V/3Ph/60Hz	S 54 A RAL 1007
0-12400303/40	400V/3Ph/60Hz	S 54 A RAL 1007
0-12400304/40	230V/3Ph/50Hz	S 54 A RAL 1007

SEMI-AUTOMATIC TRUCK TYRE CHANGER

S 560 M

STANDARD ACCESSORIES



PC
cod. 219244I



LC
cod. 801417620



LA
cod. 801217615

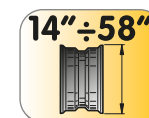

Code	Electrical Supply	Description	
0-12400501/40	400V/3ph/50Hz	S560 M RAL1007	
0-12400502/40	230V/3ph/50Hz	S560 M RAL1007	
0-12400503/40	230V/3ph/60Hz	S560 M RAL1007	

AUTOMATIC TRUCK TYRE CHANGER

S 55 - S 55A

STANDARD ACCESSORIES



PC
cod. 2192441



x4 KP56
cod. 8-12100046



LC
cod. 801417620



LA
cod. 801217615

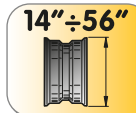
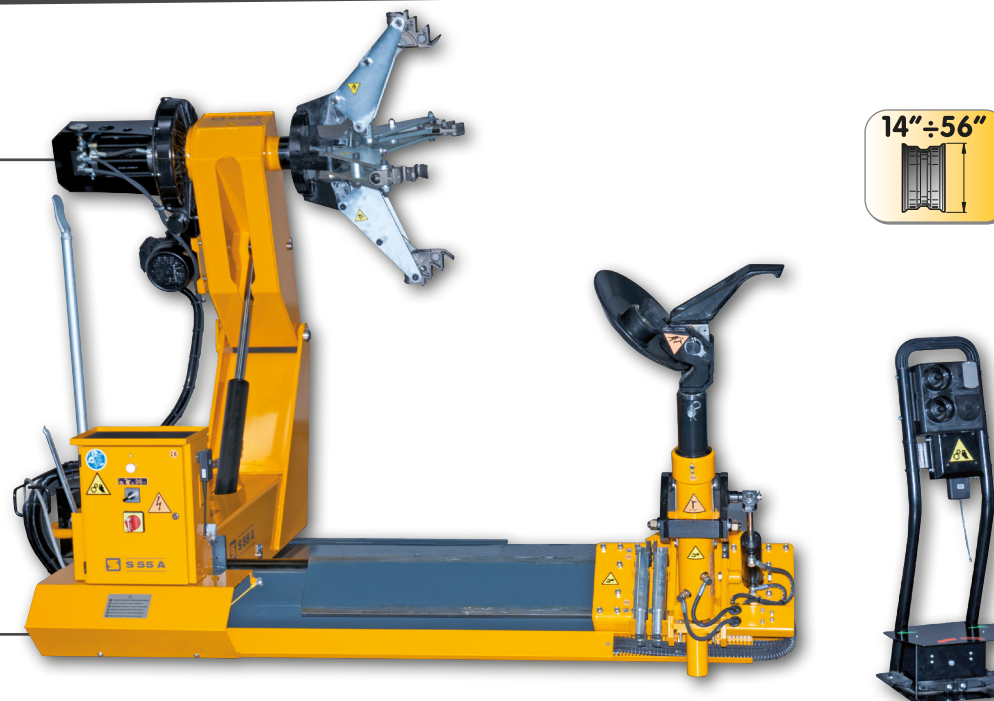

Code	Electrical Supply	Description	
0-12449001/40	400V/3Ph/50Hz	S 55 CABLE	
0-12449002/40	230V/3Ph/50Hz	S 55 CABLE	
0-12449003/40	200-208V/3Ph/60Hz	S 55 CABLE	
0-12450001/40	400V/3Ph/50Hz	S 55 ARM	
0-12450002/40	230V/3Ph/50Hz	S 55 ARM	
0-12450003/40	200-208V/3Ph/60Hz	S 55 ARM	
0-12451001/40	400V/3Ph/50Hz	S 55 A CABLE	
0-12451002/40	230V/3Ph/50Hz	S 55 A CABLE	
0-12451003/40	200-208V/3Ph/60Hz	S 55 A CABLE	
0-12452001/40	400V/3Ph/50Hz	S 55 A ARM	
0-12452002/40	230V/3Ph/50Hz	S 55 A ARM	
0-12452003/40	200-208V/3Ph/60Hz	S 55 A ARM	

S 560 EVO



STANDARD ACCESSORIES



PC
cod. 219244I



LC
cod. 801417620



LA
cod. 801217615

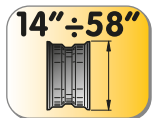

Code	Electrical Supply	Description	
0-12440115/40	400V/3Ph/50Hz	S 560 EVO RAL 1007	
0-12440116/40	230V/3Ph/50Hz	S 560 EVO RAL 1007	
0-12440117/40	230V/3Ph/60Hz	S 560 EVO RAL 1007	

AUTOMATIC TRUCK TYRE CHANGER

S 60

STANDARD ACCESSORIES



PC
cod. 2192441



LC
cod. 801417620



x 4



BBR
cod. 801289439



LA
cod. 801217615



ECO MODE

14" ÷ 60"



Code	Electrical Supply	Description	
0-12454001/40	400V/3Ph/50Hz	S 60 RAL 1007	
0-12454002/40	230V/3Ph/60Hz	S 60 RAL 1007	
0-12454003/40	400V/3Ph/60Hz	S 60 RAL 1007	

"LEVER-LESS" TRUCK TYRE CHANGER

S 58LL

STANDARD ACCESSORIES



PC
cod. 219244I



LC
cod. 801417620



LA
cod. 801217615

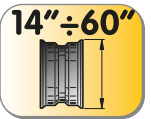

Code	Electrical Supply	Description	
0-12448001/40	400V/3Ph/50Hz	S 58 LL trolley	
0-12448002/40	200-208V/3Ph/60Hz	S 58 LL trolley	
0-12448003/40	400V/3Ph/60Hz	S 58 LL trolley	
0-12448004/40	200-208V/3Ph/60Hz	S 58 LL trolley	
0-12448005/40	400V/3Ph/50Hz	S 58 LL arm	

S 50A MOBILE

STANDARD ACCESSORIES



PC
cod. 219244I



cod. 36022258B



LC
cod. 801417620



LA
cod. 801217615

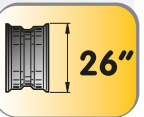

Code	Electric Supply	Description	
0-12456101/40	380V/3Ph/50Hz	S 50A Mobile, Truck mobile workshop complete with tyre changer with generator.	
0-12456001/40	380V/3Ph/50Hz	S 50A Mobile, Truck mobile workshop complete with tyre changer without generator.	





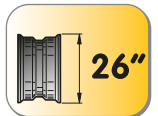

S 50 MOBILE

STANDARD ACCESSORIES







Code	Electric Supply	Description	
0-12101901/16	380V/3Ph/50Hz	S 50 Mobile, workstation complete with tyre changer with generator.	
0-12102201/16	380V/3Ph/50Hz	S 50 Mobile, workstation with tyre changer without generator.	
8-12100042		Customisation kit	

ACCESSORIES FOR TRUCK TYRE CHANGER

Image	Description	Code												
			S 52	S 52 A	S 53	S 54	S 54A	S 55 - S 55 A	S 60	S 560	S 560 Evo/ S 560 M	S 58 LL	S 50A Mobile	S 50 Mobile
BEAD PRESSING DEVICE														
	DP 12 Pneumatic bead pressing device.	2201677	O	O	O	O	O	-	O	O	O	O	-	O
TUBELESS ROLLER														
	RT Tubeless steel roller for truck and bus wheels.	2306040C	-	-	O	O	O	-	-	-	-	-	-	-
	RT Tubeless steel roller kit.	19120014	-	-	-	-	-	O	-	-	-	-	-	-
	RT Tubeless plastic roller kit.	19120016	-	-	-	-	-	O	-	-	-	-	-	-
	RTB Tubeless roller for truck and bus wheels.	801280918	-	-	-	-	-	-	-	O	O	-	-	-
	BBR Bead breaker roller (for S 520 too).	801289439	●	●	-	-	-	-	●	-	-	-	-	-





ACCESSORIES FOR TRUCK TYRE CHANGER

Image	Description	Code												
			S 52	S 52 A	S 53	S 54	S 54A	S 55 - S 55 A	S 60	S 560	S 560 Evo/ S 560 M	S 58 LL	S 50A Mobile	S 50 Mobile
PLIERS AND PINS														
	PC Rim pliers.	219244I	●	●	●	●	●	●	●	●	●	●	●	●
	PL Pliers for alloy rim.	801227195	○	○	○	○	○	○	○	○	○	○	○	○
	Skidder clamp.	801251904	○	○	○	○	○	-	○	○	○	○	-	-
	MV Pair of bead clamps for split rim wheels.	801271597	○	○	○	○	○	○	○	○	○	●	-	-
	Locking pin for alloy rims.	801237171	○	○	○	○	○	○	○	○	○	○	○	○



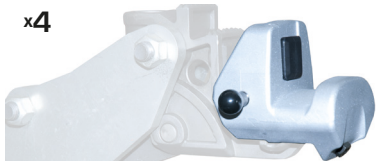

ACCESSORIES FOR TRUCK TYRE CHANGER

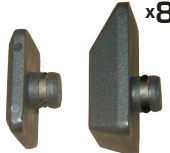
Image	Description	Code														
			S 52	S 52 A	S 53	S 54	S 54A	S 55 - S 55 A	S 60	S 560	S 560 Evo/ S 560 M	S 58 LL	S 50A Mobile	S 50 Mobile		
ADAPTOR RIMS																
	Locking adapter for alloy wheels Ø 161 mm.	8-12100007	○	○	○	○	○	○	○	○	○	○	○	○	○	○
	Locking adapter for alloy wheels Ø 164 mm.	8-12100005	○	○	○	○	○	○	○	○	○	○	○	○	○	○
	Locking adapter for alloy wheels Ø 176 mm.	8-12100006	○	○	○	○	○	○	○	○	○	○	○	○	○	○
	Locking adapter for alloy wheels Ø 202 mm.	8-12100008	○	○	○	○	○	○	○	○	○	○	○	○	○	○
	Locking adapter for alloy wheels Ø 220 mm.	8-12300001	○	○	○	○	○	○	○	○	○	○	○	○	○	○
	Locking adapter for alloy wheels Ø 221 mm.	8-12100009	○	○	○	○	○	○	○	○	○	○	○	○	○	○
	Locking adapter for alloy wheels Ø 281 mm.	8-12100010	○	○	○	○	○	○	○	○	○	○	○	○	○	○

ACCESSORIES FOR TRUCK TYRE CHANGER

Image	Description	Code													
			S 52	S 52 A	S 53	S 54	S 54A	S 55 - S 55 A	S 60	S 560	S 560 Evo/ S 560 M	S 58 LL	S 50A Mobile	S 50 Mobile	
ACCESSORIES FOR JAWS															
 <p>x4</p>	KGL56 Protection kit for alloy rims.	8-12100175	-	-	-	-	-	0	0	-	-	0	-	-	
	PCL26 Set of 4 aluminium protections for alloy rims, for S52A up to serial # IRE303002K	801254494	0	0	-	-	-	-	-	-	-	-	0	-	
	GL Jaws for alloy rims with special plastic inserts (1 Set = 4 pcs + 12 plastic inserts), for S52A from serial number IRE303002K	8-12100156	-	0	0	0	0	-	-	0	0	-	-	-	
 <p>x4 x4 x4</p>	SPI Special spare plastic inserts for GL.	8-11400200	-	-	0	0	0	-	-	0	0	-	-	-	
 <p>x8 x8</p>	SPIG Special plastic insert for jaws.	8-12100172	-	-	0	0	0	-	-	0	0	-	-	-	



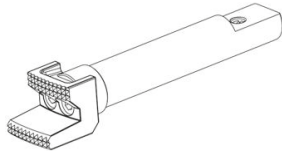

ACCESSORIES FOR TRUCK TYRE CHANGER

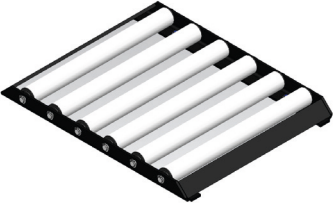
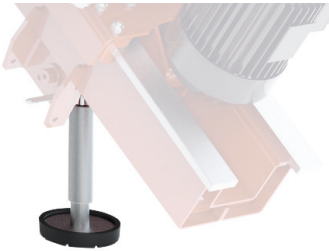
ACCESSORIES FOR TRUCK TYRE CHANGER				S 52	S 52 A	S 53	S 54	S 54A	S 55 - S 55 A	S 60	S 660	S 560 Evo/ S 560 M	S 58 LL	S 50A Mobile	S 50 Mobile
Image	Description	Code													
ACCESSORIES FOR JAWS															
 x4	P4P Four points extensions for rims with circlet.	8-12100171		-	-	-	-	-	O	O	-	-	O	-	-
	PA 4V Extensions for self-centring chuck (up to 56") (for tyre changers produced from 2012).	8-12100155		-	-	-	O	O	-	-	O	O	-	-	-
	PA26 Extensions for self-centring chuck : to increase the chuck capacity up to 28". for S52A up to serial number IRE303002K	8-12100176		-	O	-	-	-	-	-	-	-	-	O	-
 x4	Kit of 4 extensions 56" for S55	8-12100046		-	-	-	-	-	●	-	-	-	-	-	-
	Kit of extension 60".	8-12300007		-	-	-	-	-	-	-	-	-	O	-	-

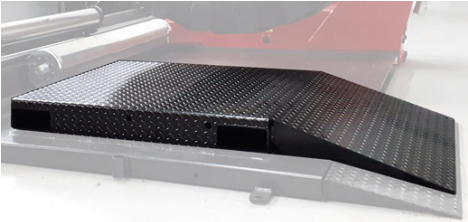

ACCESSORIES FOR TRUCK TYRE CHANGER

Image	Description	Code		S 52	S 52 A	S 53	S 54	S 54A	S 55 - S 55 A	S 60	S 560	S 560 Evo/ S 560 M	S 58 LL	S 50A MOBILE	S 50 MOBILE
MISCELLANEOUS															
	CAR MATE for S 50A Mobile	8-12120008/90		-	-	-	-	-	-	-	-	-	-	O	-
	Roller conveyor for S 50A Mobile	8-12120011/90		-	-	-	-	-	-	-	-	-	-	O	-
	Extension for loading threshold 750 mm - S 50A Mobile	8-12120009		-	-	-	-	-	-	-	-	-	-	O	-
	Extension for loading threshold 1000 mm - S 50A Mobile	8-12120010		-	-	-	-	-	-	-	-	-	-	O	-



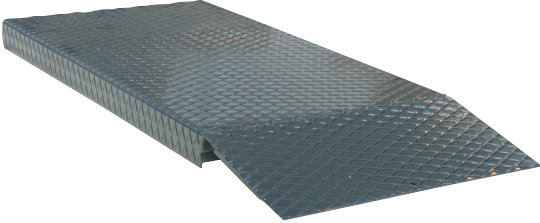

ACCESSORIES FOR TRUCK TYRE CHANGER

Image	Description	Code												
			S 52	S 52 A	S 53	S 54	S 54A	S 55 - S 55 A	S 60	S 560	S 560 Evo/ S 560 M	S 58 LL	S 50A MOBILE	S 50 MOBILE
MISCELLANEOUS														
	Horizontal charriot platform	8-12100039/40	-	O	-	-	-	-	-	-	-	-	-	-
	Side chassis platform	8-12100040/40	O	O	-	-	-	-	-	-	-	-	-	-
	Runway platform H110	8-12120023/90	-	-	-	-	-	-	O	-	-	-	-	-
	LC Split rim lever.	801417620	O	O	●	●	●	●	●	●	●	●	●	●



ACCESSORIES FOR TRUCK TYRE CHANGER

Image	Description	Code												
			S 52	S 52 A	S 53	S 54	S 54A	S 55 - S 55 A	S 60	S 560	S 560 Evo/ S 560 M	S 58 LL	S 50A MOBILE	S 50 MOBILE
MISCELLANEOUS														
	LA Bead lifting lever..	801217615	●	●	●	●	●	●	●	●	●	●	●	●
	PE Platform extension RAL7016 (for S550 too)	801280917	-	-	-	-	-	-	-	O	O	-	-	-
	UB Hook shaped tool for tubed wheels (for S520 too)	801289440	●	●	-	-	-	-	-	-	-	-	-	-

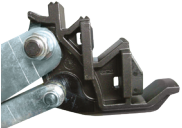
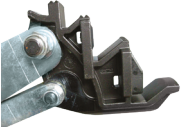



ACCESSORIES FOR TRUCK TYRE CHANGER

Image	Description	Code													
			S 52	S 52 A	S 53	S 54	S 54A	S 55 - S 55 A	S 60	S 560	S 560 Evo/ S 560 M	S 58 LL	S 50A MOBILE	S 50 MOBILE	
MISCELLANEOUS															
	BBD Bead breaking disk (for S520 too).	801289441	O	O	-	-	-	-	-	-	-	-	-	-	-
	GVA Wheel clamping collet (for S520 too).	9239121	●	-	-	-	-	-	-	-	-	-	-	-	-
	GVA/R Wheel clamping quick collet (for S520 too).	802443938	O	-	-	-	-	-	-	-	-	-	-	-	-
x4 	Kit clamps hole D. 80 mm	8-12100037	-	-	-	-	-	O	-	-	-	O	-	-	-
x4 	Set of clamps and connecting rods, 4V.	8-12100157	-	-	O	-	-	-	-	-	-	-	-	-	-
x4 	Set of monoblock clamps , 4V.	8-12100158	-	-	-	O	O	-	-	-	-	-	-	-	-
	for S 560, S 545, S 550	8-12100160	-	-	-	-	-	-	O	O	-	-	-	-	-



ACCESSORIES FOR TRUCK TYRE CHANGER

Image	Description	Code		S 52	S 52 A	S 53	S 54	S 54A	S 55 - S 55 A	S 60	S 560	S 560 Evo/ S 560 M	S 58 LL	S 50A MOBILE	S 50 MOBILE
MISCELLANEOUS															
	<p>Wireless radio kit</p>	8-12120020		-	-	-	-	-	-	-	-	-	-	O	-
	<p>Radio upgrade kit for S50A Mobile, It's required to install the Radio Kit on Machines preceding serial number CPM182480</p>	8-12120024		-	-	-	-	-	-	-	-	-	-	O	-
	<p>Trolley Radio Remote Control 2.4 GHZ From SN IFN714717 up to SN ITL819268</p>	8-12400014		-	-	-	-	-	-	O	-	-	-	-	-

ACCESSORIES FOR TRUCK TYRE CHANGER

Image	Description	Code													
			S 52	S 52 A	S 53	S 54	S 54A	S 55 - S 55 A	S 60	S 560	S 560 Evo/ S 560 M	S 58 LL	S 50A MOBILE	S 50 MOBILE	
MISCELLANEOUS															
	SGP Remote control kit for S55-S55A	8-12100026	-	-	-	-	-	-	0	-	-	-	-	-	-
	Radio Remote control kit	8-12120025/00	-	-	-	0	0	-	-	-	0	-	-	-	-
	PLR Lube brush	4216498	0	0	0	0	0	0	0	0	0	0	0	0	0
	SGG Tyre paste container with brush (4 Kg)	8-11400034	0	0	0	0	0	0	0	0	0	0	0	0	0

ACCESSORIES FOR TRUCK TYRE CHANGER

Image	Description	Code		S 52	S 52 A	S 53	S 54	S 54A	S 55 - S 55 A	S 60	S 560	S 560 Evo/ S 560 M	S 58 LL	S 50A MOBILE	S 50 MOBILE
MISCELLANEOUS															
	Bead breaker disc	8-12100030		-	-	-	-	-	-	-	-	-	-	O	O
	3 rim edge plastic protections	8-12100044		O	O	O	O	O	O	O	O	O	O	-	-
	Extensions kit for port crane rims	8-12100188		-	-	-	-	-	O	O	-	-	O	-	-

